

YASKAWA

YASKAWA AC Drive GA500

Finless-Type Drive

Installation & Primary Operation

Type: CIPR-GA50UxxxxAJxx
Models: 200 V Class, Single-Phase Input: 1/6 to 3 HP
200 V Class, Three-Phase Input: 1/6 to 25 HP
400 V Class, Three-Phase Input: 1/2 to 25 HP

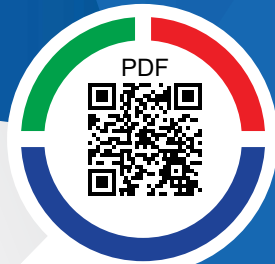

This Page Intentionally Blank

Table of Contents

1.	General Information	8
2.	Safety	8
	Explanation of Signal Words	8
	General Safety Instructions	8
	Warranty Information	10
	Exclusion of Liability	10
3.	Overview	11
4.	Drive Specifications	11
5.	Moving the Drive	15
6.	Receiving	16
	How to Read the Catalog Code	18
	Rated Output Current	19
7.	Conditions	21
	Installation Environment	21
	Heatsink Plate Temperature	22
	Monitor Heatsink Plate Temperature	23
	Overheat Alarm Level	24
	Surface Finish of Metal Surface	24
	Thermal Compound	24
	Installation Position and Clearances	24
	Drive Watt Loss	25
	Heavy Duty Rating (HD): Carrier Frequency = 2 kHz	25
	Heavy Duty Rating (HD): Carrier Frequency = Default Setting	27
	Normal Duty Rating (ND)	28

Screw Sizes and Tightening Torques	30
Install the Drive	31
Derating Depending on Ambient Temperature	32
8. Overview of Keypad Components and Functions	34
Keypad Mode and Menu Displays	39
9. Mechanical Installation	40
Drive Exterior and Mounting Dimensions	40
IP20/UL Open Type	40
Installation Position and Clearances	44
External Heatsink Selection	46
Necessary Data for External Heatsink Selection	46
External Heatsink Selection Methods	47
External Heatsink Selection	48
Removing/Reattaching Covers	49
Remove the Front Cover	50
Reattach the Front Cover	51
10. Electrical Installation	52
Standard Connection Diagram	52
Main Circuit Terminal Block Wiring Procedure	55
Wire to the Main Circuit Terminal Block	55
Main Circuit Terminal Functions	61
Wire Selection	62
Single-Phase 200 V Class	63
Three-Phase 200 V Class	65
Three-Phase 400 V Class	69
Motor and Main Circuit Connections	72
Control Circuit Terminal Block Functions	74
Input Terminals	74
Output Terminals	77
External Power Supply Input Terminals	78
Serial Communication Terminals	78
Control Circuit Terminal Configuration	78
Control Circuit Wire Gauges and Tightening Torques	79
Wiring the Control Circuit Terminal	80
Switches and Jumpers on the Terminal Board	83
Control I/O Connections	84
Set Sinking Mode/Sourcing Mode	84
Pulse Train Output	85
Set the Input Signal for the MFAI Terminal A2	87

	Set the Output Signal for the MFAO Terminal AM	88
	Switch ON Termination Resistor for MEMOBUS/Modbus Communications	89
11.	Auto-Tuning	89
	Auto-Tuning for Induction Motors	89
	Auto-Tuning for PM Motors	92
	Auto-Tuning in EZ Open Loop Vector Control Method	96
	ASR and Inertia Tuning	97
	Precautions before Auto-Tuning	98
	Prepare for Basic Auto-Tuning	98
	Precautions before Rotational Auto-Tuning	100
	Precautions before Stationary Auto-Tuning	100
	Automatically Set E2-02 [Motor Rated Slip] and E2-03 [Motor No-Load Current].	100
	Precautions before Stationary Auto-Tuning for Line-to-Line Resistance and Stator Resistance Auto-Tuning	101
	Precautions before Using Deceleration Rate Tuning and KEB Tuning	101
12.	Drive Start-Up	102
	Set up the Drive with General-Purpose Setup Mode	102
	Set and View Necessary Parameters	103
	Automatic Parameter Settings Optimized for Specific Applications (Application Presets)	104
13.	Maintenance	105
	Part Replacement Guidelines	106
14.	Drive Control, Duty Modes, and Programming	106
	Control Method Selection	106
	Drive Duty Modes	107
	Auto-Tuning for Induction Motors	107
	Drive Parameters	110
15.	Troubleshooting	116
	Fault Reset Procedure with the Keypad	116
	Fault	117
	Minor Faults/Alarms	141
	Parameter Setting Errors	154
	Auto-Tuning Errors	163
	Backup Function Operating Mode Display and Errors	170
16.	European Standards	172

EU Declaration of Conformity	173
CE Low Voltage Directive Compliance	173
Area of Use	173
Guarding Against Debris	173
Electrical Installation	173
Main Circuit Wire Gauges and Tightening Torques	175
Connect a Fuse to the Input Side (Primary Side)	186
CE Standards Compliance for DC Power Supply Input	188
EMC Directive	190
Installing the External EMC Noise Filter	190
DC Link Chokes	194
17. UL Standards	195
Conditions of Acceptability	195
Area of Use	197
Wire the Main Circuit Terminal Block	197
Notes on Wiring the Main Circuit Terminal Block	197
Main Circuit Wire Gauges and Tightening Torques	197
Short Circuit Protection	209
Low Voltage Wiring for Control Circuit Terminals	211
Drive Motor Overload and Overheat Protection	212
E2-01: Motor Rated Current (FLA)	212
E5-03: Motor Rated Current (FLA)	213
E9-06: Motor Rated Current (FLA)	213
L1-01: Motor Overload (oL1) Protection	214
L1-02: Motor Overload Protection Time	218
L1-03: Motor Thermistor oH Alarm Select	219
L1-04: Motor Thermistor oH Fault Select	220
18. China RoHS Compliance	220
Information on Hazardous Substances in This Product	221
19. 对应中国RoHS指令	221
本产品中含有有害物质的信息	222
20. Safe Disable Input	222
Safe Disable Specifications	223
Notes	224
Using the Safe Disable Function	226
Safe Disable Circuit	226
Connect Safe Disable Input Contacts to Multiple Drives	227
Enabling and Disabling the Drive Output ("Safe Torque Off")	229
Safe Disable Monitor Output Function and Keypad Display	230
Validating the Safe Disable Function	232

21. Australian Standard	232
22. Disposal	232
Disposal Instructions	232
WEEE Directive	233
Revision History	234

1 General Information

Do not use this manual as an alternative to the Technical Manual.

The products and specifications given in this manual and the manual contents can change without notice to make the product and manual better.

Be sure to always use the latest version of this manual. Use this manual to correctly install, wire, set, and operate this product.

Users can download the Technical Manual from the Yaskawa documentation website printed on the back cover.

2 Safety

Read all safety precautions before you install, wire, or operate the drive.

◆ Explanation of Signal Words

⚠ DANGER This signal word identifies a hazard that will cause serious injury or death if you do not prevent it.

⚠ WARNING This signal word identifies a hazard that can cause death or serious injuries if you do not prevent it.

⚠ CAUTION This signal word identifies a hazardous situation, which, if not avoided, can cause minor or moderate injury.

NOTICE This signal word identifies a property damage message that is not related to personal injury.

◆ General Safety Instructions

Yaskawa Electric manufactures and supplies electronic components for a variety of industrial applications. The selection and application of Yaskawa products is the responsibility of the designer of the equipment or the customer who assembles the final product. Yaskawa is not responsible for how our products are incorporated into the final system design. In all cases, Yaskawa products should not be incorporated into a product or design as the exclusive or sole safety control function. All control functions are designed to dynamically detect failures and operate safely without exception. All products that are designed to incorporate parts manufactured by Yaskawa must be provided to the end user and include proper warnings and instructions regarding their safe use and operation. All warnings from Yaskawa must be promptly issued to the end user. Yaskawa offers warranties only for the quality of our products, in compliance with standards and specifications that are described in the manual. Yaskawa does not offer other warranties, either explicit or implied. Injuries, property damage, and lost business opportunities caused by improper storage or handling and negligence oversight on the part of your company or your customers will void Yaskawa's warranty for the product.

Note:

- Read this manual carefully when mounting, operating, and repairing AC drives.
- Obey all warnings, cautions, and notices.
- Approved personnel must perform all work.
- Install the drive according to this manual and local codes.

⚠ DANGER *Do not ignore the safety messages in this manual. If you ignore the safety messages in this manual, it will cause serious injury or death. The manufacturer is not responsible for injuries or damage to equipment.*

⚠ DANGER *Electrical Shock Hazard. Do not examine, connect, or disconnect wiring on an energized drive. Before servicing, disconnect all power to the equipment and wait for the time specified on the warning label at a minimum. The internal capacitor stays charged after the drive is de-energized. The charge indicator LED extinguishes when the DC bus voltage decreases below 50 Vdc. When all indicators are OFF, measure for dangerous voltages to make sure that the drive is safe. If you do work on the drive when it is energized, it will cause serious injury or death from electrical shock.*

⚠ WARNING *Crush Hazard. Test the system to make sure that the drive operates safely after you wire the drive and set parameters. If you do not test the system, it can cause damage to equipment or serious injury or death.*

⚠ WARNING *Sudden Movement Hazard. Before you do a test run, make sure that the setting values for virtual input and output function parameters are correct. Virtual input and output functions can have different default settings and operation than wired input and output functions. Incorrect function settings can cause serious injury or death.*

⚠ WARNING *Sudden Movement Hazard. Remove all personnel and objects from the area around the drive, motor, and machine and attach covers, couplings, shaft keys, and machine loads before you energize the drive. If personnel are too close or if there are missing parts, it can cause serious injury or death.*

⚠ WARNING *Sudden Movement Hazard. Examine the I/O signals and internal sequence with the engineer who made the DriveWorksEZ program before you operate the drive. If you do not know how the drive will operate, it can cause serious injury or death. When you use DriveWorksEZ to make custom programming, the drive I/O terminal functions change from factory settings and the drive will not operate as written in this manual.*

⚠ WARNING *Electrical Shock Hazard. Do not modify the drive body or drive circuitry. Modifications to drive body and circuitry can cause serious injury or death, will cause damage to the drive, and will void the warranty. Yaskawa is not responsible for modifications of the product made by the user.*

⚠ WARNING *Electrical Shock Hazard. Only let approved personnel install, wire, maintain, examine, replace parts, and repair the drive. If personnel are not approved, it can cause serious injury or death.*

⚠ WARNING *Electrical Shock Hazard. Do not remove covers or touch circuit boards while the drive is energized. If you touch the internal components of an energized drive, it can cause serious injury or death.*

⚠ WARNING *Electrical Shock Hazard. After the drive blows a fuse or trips a GFCI, do not immediately energize the drive or operate peripheral devices. Wait for the time specified on the warning label at a minimum and make sure that all indicators are OFF. Then check the wiring and peripheral device ratings to find the cause of the problem. If you do not know the cause of the problem, contact Yaskawa before you energize the drive or peripheral devices. If you do not fix the problem before you operate the drive or peripheral devices, it can cause serious injury or death.*

⚠ WARNING *Damage to Equipment. Do not apply incorrect voltage to the main circuit of the drive. Operate the drive in the specified range of the input voltage on the drive nameplate. Voltages that are higher than the permitted nameplate tolerance can cause damage to the drive.*

NOTICE *Fire Hazard. Install sufficient branch circuit short circuit protection as specified by applicable codes and this manual. The drive is suitable for circuits that supply not more than 31,000 RMS symmetrical amperes, 240 Vac maximum (200 V Class), 480 Vac maximum (400 V Class). Incorrect branch circuit short circuit protection can cause serious injury or death.*

⚠ CAUTION *Crush Hazard. Tighten terminal cover screws and hold the case safely when you move the drive. If the drive or covers fall, it can cause moderate injury.*

NOTICE *Use an inverter-duty motor or vector-duty motor with reinforced insulation and windings applicable for use with an AC drive. If the motor does not have the correct insulation, it can cause a short circuit or ground fault from insulation deterioration.*

NOTICE *Damage to Equipment. When you touch the drive and circuit boards, make sure that you observe correct electrostatic discharge (ESD) procedures. If you do not follow procedures, it can cause ESD damage to the drive circuitry.*

NOTICE *Damage to Equipment. Do not do a withstand voltage test or use a megohmmeter or megger insulation tester on the drive. These tests can cause damage to the drive.*

NOTICE *Do not operate a drive or connected equipment that has damaged or missing parts. You can cause damage to the drive and connected equipment.*

NOTICE *Damage to Equipment. Do not use steam or other disinfectants to fumigate wood for packaging the drive. Use alternative methods, for example heat treatment, before you package the components. Gas from wood packaging fumigated with halogen disinfectants, for example fluorine, chlorine, bromine, iodine or DOP gas (phthalic acid ester), can cause damage to the drive.*

Note:

- Do not use unshielded wire for control wiring. Use shielded, twisted-pair wires and ground the shield to the ground terminal of the drive. Unshielded wire can cause electrical interference and unsatisfactory system performance.
- Do not put devices that radiate strong electromagnetic waves, for example radio transmitters, near the drive. If you use these devices near the drive, the drive can operate incorrectly.

◆ Warranty Information

■ Exclusion of Liability

- This product is not designed and manufactured for use in life-support machines or systems.
- Contact a Yaskawa representative or your Yaskawa sales representative if you are considering the application of this product for special purposes, such as machines or systems used for passenger cars, medicine, airplanes and aerospace, nuclear power, electric power, or undersea relaying.

⚠ WARNING *Injury to Personnel. When you use this product in applications where its failure could cause the loss of human life, a serious accident, or physical injury, you must install applicable safety devices. If you do not correctly install safety devices, it can cause serious injury or death.*

3 Overview

Finless-type drives do not have cooling fins, which are the main heat-generating component of the drive. The finless-type drive uses the enclosure panel (metal plate) as a cooling fin to release the heat generated by the drive. This will let you install the drive in a smaller enclosure panel.

Finless-type drives are recognized components by UL (Underwriters Laboratories Inc.).

Machines and devices integrated with this product must satisfy *Conditions of Acceptability on page 195* conditions for compliance with UL standards.

4 Drive Specifications

Note:

- To get the OLV specifications, do Rotational Auto-Tuning.
- To get the longest product life, install the drive in an environment that meets the necessary specifications.

Table 4.1 Environment

Item	Specification
Area of Use	Indoors, inside enclosure panel
Power Supply	Overvoltage Category III (IEC60664)
Ambient Temperature Setting	-10 °C to +35 °C (14 °F to 95 °F) <ul style="list-style-type: none"> • Drive reliability is better in environments where the temperature does not increase or decrease quickly. • When you install the drive in an enclosure, use a cooling fan or air conditioner to keep the internal air temperature in the permitted range. • Do not let the drive freeze. • You can use finless-type drives at a maximum of +50 °C (122 °F) when you derate the output current. <i>*/</i>
Humidity	95% RH or less Do not let condensation form on the drive.
Storage Temperature	-20 °C to +70 °C (-4 °F to +158 °F) (short-term temperature during transportation)
Surrounding Area	Pollution degree 2 or less (IEC 60664-1) Install the drive in an area without: <ul style="list-style-type: none"> • Oil mist, corrosive or flammable gas, or dust • Metal powder, oil, water, or other unwanted materials • Radioactive or flammable materials • Harmful gas or fluids • Salt • Direct sunlight Keep wood and other flammable materials away from the drive.

4 Drive Specifications

Item	Specification
Altitude	<p>1000 m (3281 ft) Maximum</p> <p>Note: Derate the output current by 1% for each 100 m (328 ft) to install the drive in altitudes between 1000 m to 4000 m (3281 ft to 13123 ft).</p> <p>It is not necessary to derate the rated voltage in these conditions:</p> <ul style="list-style-type: none"> • When you install the drive at 2000 m (6562 ft) or lower • When you install the drive between 2000 m to 4000 m (6562 ft to 13123 ft) and ground the neutral point on the power supply. Contact Yaskawa or your nearest sales representative if you will not ground the neutral point.
Vibration	<ul style="list-style-type: none"> • 10 Hz to 20 Hz: 1 G (9.8 m/s², 32.15 ft/s²) • 20 Hz to 55 Hz: 0.6 G (5.9 m/s², 19.36 ft/s²)
Installation Orientation	Install the drive vertically for sufficient airflow to cool the drive.

*1 Refer to [Derating Depending on Ambient Temperature on page 32](#) for information.

Table 4.2 Standard

Item	Specification
Harmonized Standard	<ul style="list-style-type: none"> • UL 61800-5-1 • EN 61800-3 • EN 61800-5-1 • Two Safe Disable inputs and one EDM output according to EN ISO 13849-1 (Cat.3, PL e), EN 61800-5-2 SIL3
Protection design	IP20/UL Open Type

Table 4.3 Protection Functions

Item	Specification
Motor Protection	Electronic thermal overload protection
Momentary Overcurrent Protection	Drive stops when the output current is more than 200% of the HD output current.
Overload Protection	<p>Drive stops when the output current is more than these overload tolerances:</p> <ul style="list-style-type: none"> • HD: 150% of the rated output current for 60 seconds. • ND: 110% of the rated output current for 60 seconds. <p>Note: If output frequency < 6 Hz, the drive can trigger the overload protection function when the output current is in the overload tolerance range.</p>

Item	Specification
Overvoltage Protection	200 V class: Stops when the DC bus voltage is more than approximately 410 V 400 V class: Stops when the DC bus voltage is more than approximately 820 V
Undervoltage Protection	Single-phase 200 V class: Stops when the DC bus voltage decreases to less than approximately 160 V Three-phase 200 V class: Stops when the DC bus voltage decreases to less than approximately 190 V Three-phase 400 V class: Stops when the DC bus voltage decreases to less than approximately 380 V
Momentary Power Loss Ride-thru	Stops when power loss is longer than 15 ms and continues operation if power loss is shorter than 2 s (depending on parameter settings). Note: <ul style="list-style-type: none"> • Load size and motor speed can cause the stop time to be shorter. • Drive capacity will change the continuous operation time. A Momentary Power Loss Recovery Unit is necessary to continue operation through a 2 s power loss on models 2001 to 2021 and 4001 to 4012.
Heatsink Overheat Protection	Thermistor
Braking Resistor Overheat Protection	Overheat detection for braking resistor (optional ERF-type, 3% ED)
Stall Prevention	Stall prevention is available during acceleration, deceleration, and during run.
Ground Fault Protection	Electronic circuit protection Note: <ul style="list-style-type: none"> • This protection detects ground faults during run. The drive will not provide protection when: • There is a low-resistance ground fault for the motor cable or terminal block • Energizing the drive when there is a ground fault.
DC Bus Charge LED	Charge LED illuminates when DC bus voltage is more than 50 V.

Table 4.4 Control Characteristics

Item	Specification
Control Methods	<ul style="list-style-type: none"> • V/f Control • Open Loop Vector • PM Open Loop Vector • PM Advanced Open Loop Vector • EZ Vector Control
Frequency Control Range	<ul style="list-style-type: none"> • V/f, OLV, and OLV/PM: 0.01 Hz to 590 Hz • AOLV/PM: 0.01 Hz to 270 Hz • EZOLV: 0.01 Hz to 120 Hz

4 Drive Specifications

Item	Specification
Frequency Accuracy (Temperature Fluctuation)	Digital inputs: $\pm 0.01\%$ of the maximum output frequency (-10 °C to +40 °C (14 °F to 104 °F)) Analog inputs: In $\pm 0.1\%$ of the maximum output frequency (25 °C \pm 10 °C (77 °F \pm 18 °F))
Frequency Setting Resolution	Digital inputs: 0.01 Hz Analog inputs: 1/2048 of the maximum output frequency (11-bit signed)
Output Frequency Resolution	0.001 Hz
Frequency Setting Signal	Main speed frequency reference: -10 Vdc to +10 Vdc (minimum 15 k Ω), 0 Vdc to 10 Vdc (minimum 15 k Ω), 4 mA to 20 mA (250 Ω), 0 mA to 20 mA (250 Ω) Main speed reference: Pulse train input (maximum 32 kHz)
Starting Torque	<ul style="list-style-type: none"> • V/f: 150%/3 Hz • OLV: 150%/1 Hz • OLV/PM: 100%/5% speed • AOLV/PM: 100%/0 min⁻¹ (when high frequency injection is enabled) • EZOLV: 100%/10% speed <p>Note: Correctly select the drive and motor capacity for this starting torque in these control methods:</p> <ul style="list-style-type: none"> • OLV • AOLV/PM
Speed Control Range	<ul style="list-style-type: none"> • V/f: 1:40 • OLV: 1:100 • OLV/PM: 1:10 • AOLV/PM: 1:100 (when high frequency injection is enabled) • EZOLV: 1:10
Zero Speed Control	Possible in AOLV/PM control methods.
Torque Limits	You can use parameter settings for different limits in four quadrants in these control methods: <ul style="list-style-type: none"> • OLV • AOLV/PM • EZOLV
Acceleration and Deceleration Times	0.0 s to 6000.0 s The drive can set four pairs of different acceleration and deceleration times.

Item	Specification
Braking Torque	<p>Approximately 20% without a resistor Approximately 125% with a dynamic braking option</p> <p>▲ WARNING Set L3-04 = 0 [Stall Prevention during Decel = Disabled] when you operate the drive with:</p> <ul style="list-style-type: none"> • a regenerative converter • regenerative unit • braking resistor • braking resistor unit. <p><i>If you set the parameter incorrectly, the drive can decelerate for too long and cause serious injury or death.</i></p> <p>Note:</p> <ul style="list-style-type: none"> • Short-time average deceleration torque refers to the torque needed to decelerate the motor (uncoupled from the load) from the rated speed to zero. Motor characteristics can change the actual specifications. • Motor characteristics change the continuous regenerative torque and short-time average deceleration torque for motors 2.2 kW and larger.
V/f Characteristics	Select from 15 pre-defined V/f patterns, or a user-set V/f pattern.
Main Control Functions	Feed Forward Control, Restart After Momentary Power Loss, Speed Search, Overtorque Detection, Torque Limit, 17 Step Speed (max.), Accel/Decel Switch, S-curve Acceleration/Deceleration, 3-wire Sequence, Auto-Tuning (Rotational and Stationary), Dwell Function, Cooling Fan ON/OFF Switch, Slip Compensation, Torque Compensation, Frequency Jump, Upper/Lower Limits for Frequency Reference, DC Injection Braking at Start and Stop, Overexcitation Braking, High Slip Braking, PID Control (with Sleep Function), Energy Saving Control, MEMOBUS/Modbus Communications (RS-485 max, 115.2 kbps), Auto Restart, Application Presets, DriveWorksEZ (customized functions), Parameter Backup Function, Online Tuning, KEB, Overexcitation Deceleration, Overvoltage Suppression, High Frequency Injection, etc.

5 Moving the Drive

When you move and install this product, make sure that you obey local laws and regulations.

▲ CAUTION *Crush Hazard. Do not hold the drive by the keypad or front cover. Tighten the screws correctly when you move the drive. If the drive or covers fall, it can cause moderate injury.*

6 Receiving

The product packaging contains the product and instruction manual.

1. Examine the drive for damage or missing parts. Immediately contact the shipping company if the drive is damaged. The Yaskawa warranty does not cover damage from shipping.
2. Examine the catalog code to make sure that you received the correct model. Examine the catalog code in the “C/C” section of the drive nameplate to make sure that you received the correct model.
3. Contact your supplier or Yaskawa sales office if you received an incorrect drive model or if the drive does not operate correctly.
4. When you operate more than one drive, check all drives and motors separately.

NOTICE

Do not operate a drive or connected equipment that has damaged or missing parts. You can cause damage to the drive and connected equipment.

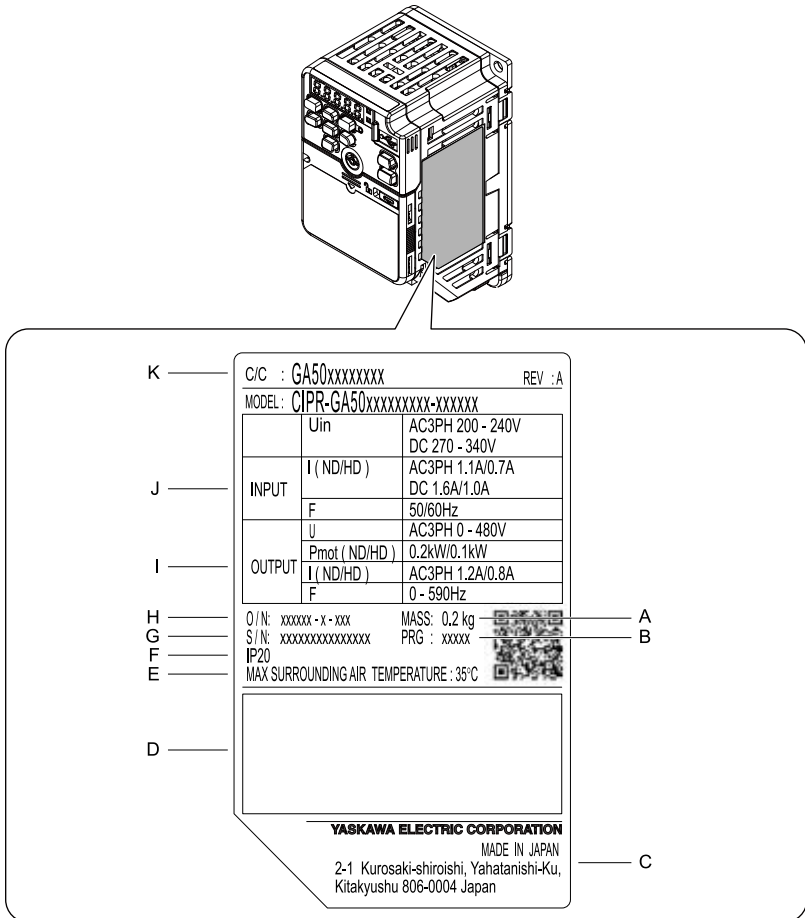

- | | |
|---|----------------------------------|
| A - Weight | G - Product number |
| B - Drive software version | H - Serial number |
| C - The address of the head office of Yaskawa Electric Corporation | I - Output specifications |
| D - Accreditation standards | J - Input specifications |
| E - Ambient temperature specification | K - Catalog code |
| F - Enclosure protection design | |

Figure 6.1 Nameplate Information Example

◆ How to Read the Catalog Code

Use the information in [Figure 6.2](#) and [Table 6.1](#) to read the drive catalog code.

<u>GA50</u>	<u>U</u>	<u>4</u>	<u>004</u>	<u>A</u>	<u>J</u>	<u>A</u>
1	2	3	4	5	6	7

Figure 6.2 Drive Catalog Code

Table 6.1 Catalog Code Details

No.	Description
1	Product series
2	Region code <ul style="list-style-type: none"> • A: Japan • B: China • C: Europe • T: Asia (Singapore, Taiwan, India, and Korea) • U: Americas
3	Input power supply voltage <ul style="list-style-type: none"> • B: Single-Phase AC 200 V Class • 2: Three-Phase AC 200 V Class • 4: Three-Phase AC 400 V Class
4	Rated output current ^{*1}
5	EMC noise filter (Finless-type drives do not have built-in EMC filters) A: Standard (No built-in EMC filter)
6	Enclosure protection design J: Finless (IP20/UL Open Type)
7	Environmental specification <ul style="list-style-type: none"> • A: Standard • K: Gas-resistant • M: Humidity-resistant and dust-resistant • N: Oil-resistant • P: Humidity-resistant, dust-resistant, and vibration-resistant • S: Vibration-resistant <p>Note: Drives with these specifications do not guarantee complete protection for the environmental conditions shown.</p>

*1 Refer to [Rated Output Current on page 19](#) for the rated output current by model.

■ Rated Output Current

Table 6.2, Table 6.3, and Table 6.4 give the rated output current values.

Note:

- Rated output current values are applicable for drives that operate at standard specifications.
- Derate the output current in applications that:
 - Increase the carrier frequency
 - Have high ambient temperature
- Use C6-01 [Normal / Heavy Duty Selection] to select Normal Duty rating (ND) or Heavy Duty rating (HD).

Table 6.2 Single-Phase AC 200 V Class

Model	Heavy Duty Rating (HD) [C6-01 = 0]		Normal Duty Rating (ND) [C6-01 = 1] (Default)	
	Maximum Applicable Motor Output kW (HP)	Rated Output Current A	Maximum Applicable Motor Output kW (HP)	Rated Output Current A
B001	0.1 (1/6)	0.8	0.2 (1/6)	1.2
B002	0.2 (1/4)	1.6	0.4 (1/4)	1.9
B004	0.4 (1/2)	3.0	0.75 (3/4)	3.5
B006	0.75 (1)	5.0	1.1 (1.5)	6.0
B010	1.5 (2)	8.0	2.2 (3)	9.6
B012	2.2 (3)	11.0	3.0 (3)	12.2

Table 6.3 Three-Phase AC 200 V Class

Model	Heavy Duty Rating (HD) [C6-01 = 0]		Normal Duty Rating (ND) [C6-01 = 1] (Default)	
	Maximum Applicable Motor Output kW (HP)	Rated Output Current A	Maximum Applicable Motor Output kW (HP)	Rated Output Current A
2001	0.1 (1/6)	0.8	0.2 (1/6)	1.2
2002	0.2 (1/4)	1.6	0.4 (1/4)	1.9
2004	0.4 (1/2)	3.0	0.75 (3/4)	3.5
2006	0.75 (1)	5.0	1.1 (1.5)	6.0
2010	1.5 (2)	8.0	2.2 (3)	9.6

Model	Heavy Duty Rating (HD) [C6-01 = 0]		Normal Duty Rating (ND) [C6-01 = 1] (Default)	
	Maximum Applicable Motor Output kW (HP)	Rated Output Current A	Maximum Applicable Motor Output kW (HP)	Rated Output Current A
2012	2.2 (3)	11.0	3.0 (4)	12.2
2021	3.7 (5)	17.6	5.5 (5)	21.0
2030	5.5 (7.5)	25.0	7.5 (10)	30
2042	7.5 (10)	33.0	11 (15)	42
2056	11 (15)	47.0	15 (20)	56
2070	15 (20)	60.0	18.5 (25)	70

Table 6.4 Three-Phase AC 400 V Class

Model	Heavy Duty Rating (HD) [C6-01 = 0]		Normal Duty Rating (ND) [C6-01 = 1] (Default)	
	Maximum Applicable Motor Output kW (HP)	Rated Output Current A	Maximum Applicable Motor Output kW (HP)	Rated Output Current A
4001	0.2 (1/2)	1.2	0.4 (1/2)	1.2
4002	0.4 (3/4)	1.8	0.75 (1)	2.1
4004	0.75 (2)	3.4	1.5 (2)	4.1
4005	1.5 (3)	4.8	2.2 (3)	5.4
4007	2.2 (3)	5.6	3.0 (4)	7.1
4009	3.0 (4)	7.3	3.7 (5)	8.9
4012	3.7 (5)	9.2	5.5 (7.5)	11.9
4018	5.5 (10)	14.8	7.5 (10)	17.5
4023	7.5 (10)	18.0	11 (15)	23.4
4031	11 (15)	24.0	15 (20)	31.0
4038	15 (20)	31.0	18.5 (25)	38.0

7 Conditions

Obey the installation conditions specified in this guide to take full advantage of the finless design of this drive.

◆ Installation Environment

The installation environment is important for the lifespan of the product and to make sure that the drive performance is correct. Make sure that the installation environment agrees with the specifications shown in [Table 7.1](#).

Table 7.1 Installation Environment

Environment	Conditions
Area of Use	Indoors, inside enclosure panel
Power Supply	Overvoltage Category III (IEC60664)
Ambient Temperature Setting	<p>-10 °C to +35 °C (14 °F to 95 °F)</p> <ul style="list-style-type: none"> • Drive reliability is better in environments where the temperature does not increase or decrease quickly. • When you install the drive in an enclosure, use a cooling fan or air conditioner to keep the internal air temperature in the permitted range. • Do not let the drive freeze. • You can use finless-type drives at a maximum of +50 °C (122 °F) when you derate the output current. [*]/₁
Humidity	<p>95%RH or less</p> <p>Do not let condensation form on the drive.</p>
Storage Temperature	-20 °C to +70 °C (-4 °F to +158 °F) (short-term temperature during transportation)
Surrounding Area	<p>Pollution degree 2 or less (IEC 60664-1)</p> <p>Install the drive in an area without:</p> <ul style="list-style-type: none"> • Oil mist, corrosive or flammable gas, or dust • Metal powder, oil, water, or other unwanted materials • Radioactive or flammable materials. • Harmful gas or fluids • Salt • Direct sunlight <p>Keep wood and other flammable materials away from the drive.</p>

Environment	Conditions
Altitude	1000 m (3281 ft) Maximum Note: Derate the output current by 1% for each 100 m (328 ft) to install the drive in altitudes between 1000 m to 4000 m (3281 ft to 13123 ft). It is not necessary to derate the rated voltage in these conditions: <ul style="list-style-type: none"> • When you install the drive at 2000 m (6562 ft) or lower • When you install the drive between 2000 m to 4000 m (6562 ft to 13123 ft) and ground the neutral point on the power supply. Contact Yaskawa or your nearest sales representative if you will not ground the neutral point.
Vibration	<ul style="list-style-type: none"> • 10 Hz to 20 Hz: 1 G (9.8 m/s², 32.15 ft/s²) • 20 Hz to 55 Hz: 0.6 G (5.9 m/s², 19.36 ft/s²)
Installation Orientation	Install the drive vertically for sufficient airflow to cool the drive.

*1 Refer to [Derating Depending on Ambient Temperature on page 32](#) for information.

NOTICE Do not put drive peripheral devices, transformers, or other electronics near the drive. Shield the drive from electrical interference if components must be near the drive. Components near the drive can cause incorrect drive operation from electrical interference.

NOTICE Do not let unwanted objects, for example metal shavings or wire clippings, fall into the drive during drive installation. Put a temporary cover over the drive during installation. Remove the temporary cover before start-up. Unwanted objects inside of the drive can cause damage to the drive.

◆ Heatsink Plate Temperature

CAUTION Burn Hazard. Do not touch a hot drive heatsink or external heatsink. Yaskawa recommends that you show a high temperature warning mark or warning sign on the external heatsink. If you touch a hot drive heatsink plate or external heatsink, it can burn you.

Keep the drive heatsink plate temperature lower than the maximum temperature even when the ambient temperature is 50 °C (122 °F). Refer to [Table 7.2](#) for the maximum temperature of the heatsink plate. When you operate the drive in an ambient temperature of 35 °C (95 °F) or higher, refer to [Derating Depending on Ambient Temperature on page 32](#) and derate the drive.

Table 7.2 Maximum Temperature of the Heatsink Plate

Model	Maximum Temperature of the Heatsink Plate
B001 - B012	90 °C (194 °F)
2001 - 2021	90 °C (194 °F)
2030 - 2070	80 °C (176 °F)

Model	Maximum Temperature of the Heatsink Plate
4001 - 4012	90 °C (194 °F)
4018 - 4038	80 °C (176 °F)

Refer to *Drive Watt Loss on page 25* for the drive watt loss data.

Refer to *Monitor Heatsink Plate Temperature on page 23* to monitor drive heatsink plate temperature.

■ Monitor Heatsink Plate Temperature

- When you use the drive keypad
Set *U4-08 [Heatsink Temperature]* to show the drive heatsink temperature.



Figure 7.1 U4-08 [Heatsink Temperature] (When the heatsink plate is 89 °C)

- When you use a Multi-function Analog Monitor Output
When you use terminal AM, set the parameters as shown in [Table 7.3](#).

Table 7.3 MFAO Settings

Parameter	Name	Setting
H4-01	Terminal AM Analog Output Select	408 (<i>U4-08</i>)
H4-02	Terminal AM Analog Output Gain	100.0%
H4-03	Terminal AM Analog Output Bias	0.0%

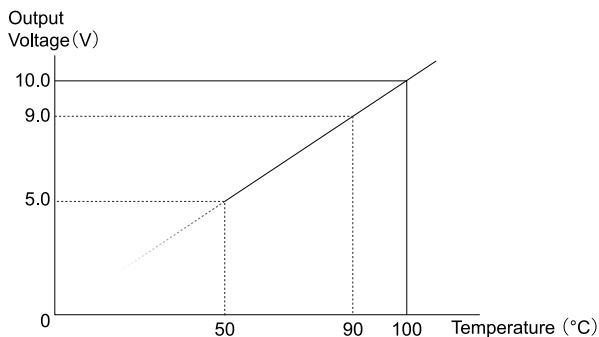

Figure 7.2 Heatsink Plate Temperature Output on MFAO

Note:

- The accuracy is ± 5 °C (41 °F) for heatsink plate temperatures between 50 °C to 100 °C (122 °F to 212 °F).
- The installation environment has an effect on the temperature.

■ Overheat Alarm Level

If the heatsink temperature is more than the temperature set in *L8-02 [Overheat Alarm Level]*, the drive detects *oH [Heatsink Overheat]*. To enable this function, set one of *H2-0x [MFDO Function Select]* to *20 [Drive Overheat Pre-Alarm (oH)]*.

Use *L8-03 [Overheat Alarm Level]* to set the operation when the drive detects *oH [Heatsink Overheat]*.

Refer to the drive Technical Reference for more information.

◆ Surface Finish of Metal Surface

Make sure that the metal surface to which you will install the drive meets these specifications:

- Flatness: ≤ 0.2 mm (0.0078 in)
- Roughness: ≤ 25 S

Note:

A roughness of 25 S means that the average roughness “Ra” is 6.3 μ m and the maximum peak “Rz” is 25 μ m.

◆ Thermal Compound

The thermal compound bonds the heating and cooling elements to each other and increases thermal transfer.

Apply the thermal compound between the heatsink plate and the mating surface. The applicable thermal compound is different for different external heatsinks. When you select and apply a thermal compound, contact the thermal compound manufacturer for additional information.

[Table 7.4](#) shows an example of thermal compound selection.

Table 7.4 Example of Thermal Compound Selection

Manufacturer	Type	Model	Application Amount (Thickness)
Shin-Etsu Chemical Co., Ltd.	Oil-based compound	X-23-7795	100 μ m - 250 μ m ^{*1}

*1 The thickness can change with the condition of the metal surface.

◆ Installation Position and Clearances

Use the clearances specified in [Figure 7.3](#) to install the drive. Make sure that there is sufficient space for wiring and airflow.

Tightly push the drive heatsink plate against the metal surface (enclosure panel) for correct thermal transfer between the drive and the metal surface.

Note:

You cannot install finless-type drives side-by-side.

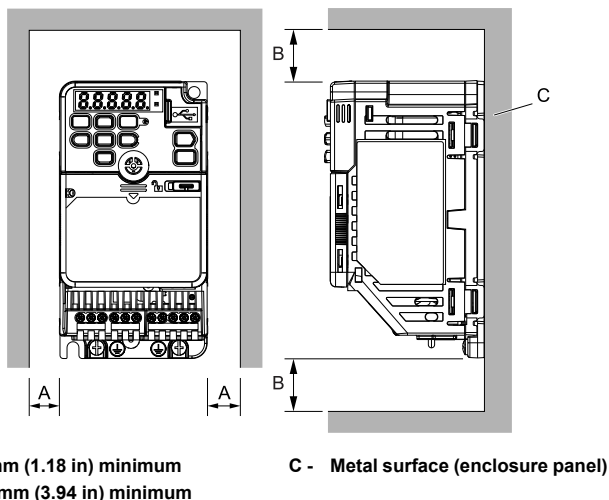

Figure 7.3 Installation Clearances

◆ Drive Watt Loss

■ Heavy Duty Rating (HD): Carrier Frequency = 2 kHz

Table 7.5 Single-Phase 200 V Class (Finless-Type Drive)

Drive Model	Rated Output Current (A)	Carrier Frequency (kHz)	Drive Watt Loss (W)		
			Interior Unit Loss	Heatsink Plate Loss (P_{Loss})	Total Loss
B001	0.8	2	7	4	11
B002	1.6	2	10	7	17
B004	3	2	13	13	26
B006	5	2	17	23	40
B010	8	2	30	37	67
B012	11	2	40	48	88

Table 7.6 Three-Phase 200 V Class (Finless-Type Drive)

Drive Model	Rated Output Current (A)	Carrier Frequency (kHz)	Drive Watt Loss (W)		
			Interior Unit Loss	Heatsink Plate Loss (P _{Loss})	Total Loss
2001	0.8	2	6	4	10
2002	1.6	2	7	7	14
2004	3.0	2	9	13	22
2006	5.0	2	13	22	35
2010	8.0	2	17	37	54
2012	11.0	2	23	49	72
2021	17.6	2	36	83	119
2030	25.0	2	46	139	185
2042	33.0	2	67	175	242
2056	47.0	2	95	284	379
2070	60.0	2	157	377	534

Table 7.7 Three-Phase 400 V Class (Finless-Type Drive)

Drive Model	Rated Output Current (A)	Carrier Frequency (kHz)	Drive Watt Loss (W)		
			Interior Unit Loss	Heatsink Plate Loss (P _{Loss})	Total Loss
4001	1.2	2	8	7	15
4002	1.8	2	10	10	20
4004	3.4	2	13	21	34
4005	4.8	2	15	29	44
4007	5.6	2	16	33	49
4009	7.3	2	21	45	66
4012	9.2	2	27	60	87
4018	14.8	2	44	105	149
4023	18	2	76	146	220

Drive Model	Rated Output Current (A)	Carrier Frequency (kHz)	Drive Watt Loss (W)		
			Interior Unit Loss	Heatsink Plate Loss (P _{Loss})	Total Loss
4031	24	2	62	167	229
4038	31	2	89	222	311

■ **Heavy Duty Rating (HD): Carrier Frequency = Default Setting**

Table 7.8 Single-Phase 200 V Class (Finless-Type Drive)

Drive Model	Rated Output Current (A)	Carrier Frequency (kHz)	Drive Watt Loss (W)		
			Interior Unit Loss	Heatsink Plate Loss (P _{Loss})	Total Loss
B001	0.8	10	8	5	13
B002	1.6	10	10	9	19
B004	3	10	14	16	30
B006	5	10	18	28	46
B010	8	8	31	42	73
B012	11	8	41	55	96

Table 7.9 Three-Phase 200 V Class (Finless-Type Drive)

Drive Model	Rated Output Current (A)	Carrier Frequency (kHz)	Drive Watt Loss (W)		
			Interior Unit Loss	Heatsink Plate Loss (P _{Loss})	Total Loss
2001	0.8	10	6	5	11
2002	1.6	10	7	8	15
2004	3.0	10	10	16	26
2006	5.0	10	14	27	41
2010	8.0	8	18	43	61
2012	11.0	8	24	56	80
2021	17.6	8	40	108	148
2030	25.0	8	50	163	214

Drive Model	Rated Output Current (A)	Carrier Frequency (kHz)	Drive Watt Loss (W)		
			Interior Unit Loss	Heatsink Plate Loss (P _{Loss})	Total Loss
2042	33.0	8	73	212	285
2056	47.0	8	108	347	455
2070	60.0	8	171	455	626

Table 7.10 Three-Phase 400 V Class (Finless-Type Drive)

Drive Model	Rated Output Current (A)	Carrier Frequency (kHz)	Drive Watt Loss (W)		
			Interior Unit Loss	Heatsink Plate Loss (P _{Loss})	Total Loss
4001	1.2	8	9	11	20
4002	1.8	8	11	16	27
4004	3.4	8	15	31	46
4005	4.8	8	18	42	60
4007	5.6	8	18	49	67
4009	7.3	8	25	65	90
4012	9.2	8	32	85	117
4018	14.8	8	52	149	201
4023	18	8	92	207	299
4031	24	8	75	240	315
4038	31	8	108	319	427

■ Normal Duty Rating (ND)

Table 7.11 Single-Phase 200 V Class (Finless-Type Drive)

Drive Model	Rated Output Current (A)	Carrier Frequency (kHz)	Drive Watt Loss (W)		
			Interior Unit Loss	Heatsink Plate Loss (P _{Loss})	Total Loss
B001	1.2	2	8	6	14
B002	1.9	2	14	11	25

Drive Model	Rated Output Current (A)	Carrier Frequency (kHz)	Drive Watt Loss (W)		
			Interior Unit Loss	Heatsink Plate Loss (P _{Loss})	Total Loss
B004	3.5	2	14	17	31
B006	6.0	2	17	26	43
B010	9.6	2	36	50	86
B012	12.2	2	48	60	108

Table 7.12 Three-Phase 200 V Class (Finless-Type Drive)

Drive Model	Rated Output Current (A)	Carrier Frequency (kHz)	Drive Watt Loss (W)		
			Interior Unit Loss	Heatsink Plate Loss (P _{Loss})	Total Loss
2001	1.2	2	7	5	12
2002	1.9	2	9	9	18
2004	3.5	2	11	16	27
2006	6	2	14	25	39
2010	9.6	2	25	51	76
2012	12.2	2	30	61	91
2021	21	2	52	111	163
2030	30	2	59	175	234
2042	42	2	101	250	351
2056	56	2	127	357	484
2070	70	2	202	455	657

Table 7.13 Three-Phase 400 V Class (Finless-Type Drive)

Drive Model	Rated Output Current (A)	Carrier Frequency (kHz)	Drive Watt Loss (W)		
			Interior Unit Loss	Heatsink Plate Loss (P _{Loss})	Total Loss
4001	1.2	2	8	7	15
4002	2.1	2	13	12	25
4004	4.1	2	14	24	38

Drive Model	Rated Output Current (A)	Carrier Frequency (kHz)	Drive Watt Loss (W)		
			Interior Unit Loss	Heatsink Plate Loss (P _{Loss})	Total Loss
4005	5.4	2	16	32	48
4007	7.1	2	20	44	64
4009	8.9	2	28	58	86
4012	11.9	2	39	83	122
4018	17.5	2	58	146	203
4023	23.4	2	81	204	286
4031	31	2	99	259	357
4038	38	2	141	319	460

◆ Screw Sizes and Tightening Torques

Table 7.14 shows the correct screw sizes and tightening torques to safety the drive to a metal surface (enclosure panel).

Table 7.14 Screw Sizes and Tightening Torques

Drive Model	Screw Size	Tightening Torque N·m (lbf·in)
B001 - B012	M5	2.0 - 2.5 (17.7 - 22.1)
2001 - 2021	M5	2.0 - 2.5 (17.7 - 22.1)
2030 - 2056	M5	2.0 - 2.5 (17.7 - 22.1)
2070	M6	4.0 - 5.0 (35.4 - 44.3)
4001 - 4012	M5	2.0 - 2.5 (17.7 - 22.1)
4018 - 4038	M5	2.0 - 2.5 (17.7 - 22.1)

NOTICE

Damage to Equipment. Tighten the screws to the specified tightening torque. Incorrect tightening torque can cause too much heat and damage to the drive.

◆ Install the Drive

Apply the thermal compound across the full surface of the application area on the heatsink. Tightly push the drive against the metal surface (enclosure panel).

Clean off the unwanted thermal compound from around the drive perimeter.

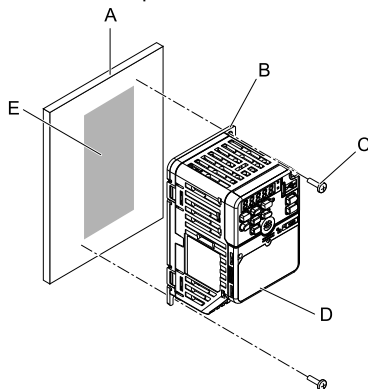

A - Metal surface (enclosure panel)

B - Heatsink plate

C - Screws

D - Finless-type drive

E - Drive mounting area

Figure 7.4 Install the Drive

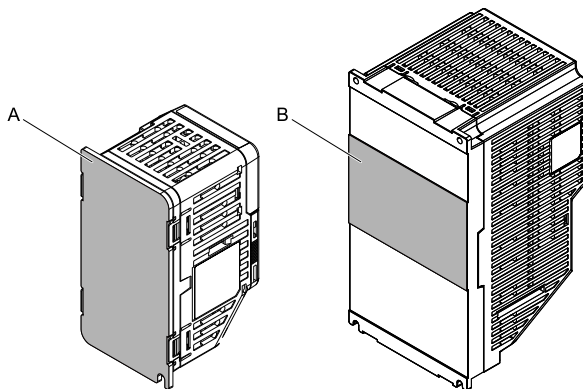

A - Application area (B001 to B012, 2001 to 2021, 4001 to 4012)

B - Application area (2030 to 2070, 4018 to 4038)

Figure 7.5 Thermal Compound Application Area

Note:

You can mill the metal surface to be more flat and use less thermal compound. Recommended flatness is 0.05 mm (0.00197 in) or less. After you mill the metal surface, tightly push the drive against it.

◆ Derating Depending on Ambient Temperature

When you install drives in an area where ambient temperatures are higher than the rated conditions, set *L8-12 [Ambient Temperature Setting]* and *L8-35 [Installation Method Selection]*. Derate the output current as specified in [Figure 7.6](#).

No. (Hex.)	Name	Description	Default (Range)
L8-12 (04B8)	Ambient Temperature Setting	<input type="checkbox"/> V/f <input type="checkbox"/> OLV <input type="checkbox"/> OLV/PM <input type="checkbox"/> AOLV/PM <input type="checkbox"/> EZOLV Sets the ambient temperature of the drive installation area.	40 °C (-10 °C - +60 °C)

No. (Hex.)	Name	Description	Default (Range)
L8-35 (04EC)	Installation Method Selection	<input type="checkbox"/> V/f <input type="checkbox"/> OLV <input type="checkbox"/> OLV/PM <input type="checkbox"/> AOLV/PM <input type="checkbox"/> EZOLV Sets the type of drive installation.	3 (0 - 3)

0 : IP20/UL Open Type

Use this setting to install IP20/UL Open Type drives.

Make sure that there is 30 mm (1.18 in) minimum of space between drives or between the drive and side of the enclosure panel.

1 : Side-by-Side Mounting

Use this setting to install more than one drive side-by-side.

You cannot install finless-type drives side-by-side.

2 : IP20/UL Type 1

Use this setting to install IP20/UL Type 1 drives.

You cannot install a UL Type 1 Kit (optional) on a finless-type drive.

3 : External Heatsink/Finless

Use this setting when the heatsink (cooling fin) is outside the enclosure panel or when you install a finless-type drive.

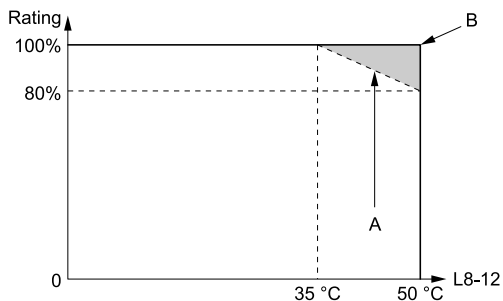

A - L8-35 = 3 [External Heatsink/
Finless] (default setting)

B - L8-35 = 0 [IP20/UL Open Type] (0.5
m/s of airflow around the drive is
necessary)

Figure 7.6 Derating Depending on Drive Installation Method

8 Overview of Keypad Components and Functions

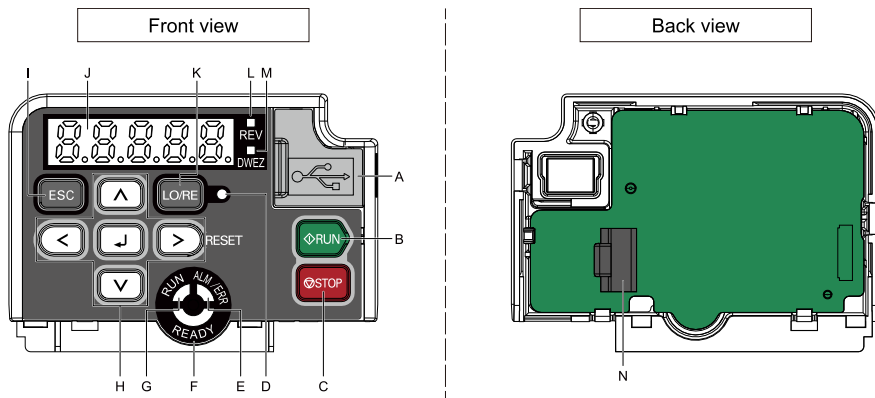

















Figure 8.1 Keypad





Table 8.1 Keypad Components and Functions

Symbol	Name	Function
A	USB Terminal Pass-through	Pass-through point to connect a USB cable to the drive to use the DriveWizard PC tool or the DriveWizard Mobile App to program the drive. Uses a USB cable (USB standard 2.0, type A - mini-B) to connect the drive to a PC, Android smartphone, or tablet.
B	RUN Key 	Starts the drive in LOCAL Mode. Starts the operation in Auto-Tuning Mode. Note: Before you use the keypad to operate the motor, push  on the keypad to set the drive to LOCAL Mode.
C	STOP Key 	Stops drive operation. Note: Uses a stop-priority circuit. Push  to stop the motor. This will also apply when a Run command (REMOTE Mode) is active at an external Run command source. To disable  priority, set $a2-02 = 0$ [<i>STOP Key Function Selection = Disabled</i>].

Symbol	Name	Function
D	LO/RE LED 	Illuminated: The keypad controls the Run command (LOCAL Mode). OFF: The control circuit terminal or serial transmission device controls the Run command (REMOTE Mode). Note: <ul style="list-style-type: none"> • LOCAL: Use the keypad to operate the drive. Use the keypad to enter Run/ Stop commands and the frequency reference command. • REMOTE: Use the control circuit terminal or serial transmission to operate the drive. Use the frequency reference source entered in <i>b1-01</i> and the Run command source selected in <i>b1-02</i>.
E	ALM/ERR LED 	Illuminated: The drive detects a fault. OFF: There are no drive faults or alarms. Flashing: <ul style="list-style-type: none"> • Alarm • Operation Errors • An Auto-Tuning error Note: The LED will illuminate to identify a fault if the drive detects a fault and an alarm at the same time.
F	READY LED 	Illuminated: The drive is operating or is ready for operation. OFF: <ul style="list-style-type: none"> • The drive detects a fault. • There is no fault and the drive received a Run command, but the drive cannot run. For example, in Programming Mode. Flashing: The drive is in <i>STo</i> [<i>Safe Torque OFF</i>] condition. Flashing quickly: The voltage of the main circuit power supply is not in the drive nameplate specifications, and the external 24 V power supply is providing the only power to the drive.

8 Overview of Keypad Components and Functions

Symbol	Name	Function
G	RUN LED 	<p>Illuminated: The drive is in normal operation.</p> <p>OFF: The drive is stopped.</p> <p>Flashing:</p> <ul style="list-style-type: none"> The drive is decelerating to stop. The drive received a Run command with a frequency reference of 0 Hz, but the drive is not set for zero speed control <p>Flashing quickly:</p> <ul style="list-style-type: none"> The drive received a Run command from the MFDI terminals while in LOCAL Mode and it switched to REMOTE Mode. The drive received a Run command from the MFDI terminals when the drive is not in Drive Mode. The drive received a Fast Stop command. The safety function shut off the drive output. <ul style="list-style-type: none"> You pushed  on the keypad while the drive is operating in REMOTE Mode. The drive is energized with an active Run command and $b1-17 = 0$ [Run Command at Power Up = Disregard Existing RUN Command].
H	Left Arrow Key 	Moves the cursor to the left.
	Up Arrow Key/ Down Arrow Key 	<ul style="list-style-type: none"> Moves to a different screen. Selects parameter numbers and increments or decrements setting values.
	Right Arrow Key (RESET) 	<ul style="list-style-type: none"> Moves the cursor to the right. Resets the drive to clear a fault.
	ENTER Key 	<ul style="list-style-type: none"> Enters parameter values and settings. Selects each mode, parameter, and set value.
I	ESC Key 	<ul style="list-style-type: none"> Goes back to the previous screen. Push and hold to go back to the frequency reference screen (the initial screen).
J	LED Display	Shows parameters, errors, and other data.

Symbol	Name	Function
K	LO/RE Selection Key 	Switches drive control for the Run command and frequency reference between the keypad (LOCAL) and an external source (REMOTE). Note: <ul style="list-style-type: none"> The LOCAL/REMOTE Selection Key continuously stays enabled after the drive stops in Drive Mode. If the application must not switch from REMOTE to LOCAL because it will have a negative effect on system performance, set $o2-01 = 0$ [LO/RE Key Function Selection = Disabled] to disable . The drive will not switch between LOCAL and REMOTE when it is receiving a Run command from an external source.
L	REV LED 	Illuminated: The drive received a Reverse run command.
M	DWEZ LED 	Illuminated: The drive is In DriveWorksEZ operation.
N	RJ-45 Connector	Connects to the drive. Use an RJ-45 8-pin straight UTP CAT5e extension cable to install the keypad in a different location than the drive.

▲ WARNING *Sudden Movement Hazard. If you change the control source when $b1-07 = 1$ [LOCAL/REMOTE Run Selection = Accept Existing RUN Command], the drive can start suddenly. Before you change the control source, remove all personnel from the area around the drive, motor, and load. Sudden starts can cause serious injury or death.*

Drive models GA50A*****_****L* ship from the factory with a blank cover instead of a keypad. To set parameters on these models, connect an optional keypad or engineering tool to one of the connection ports shown in [Figure 8.2](#).

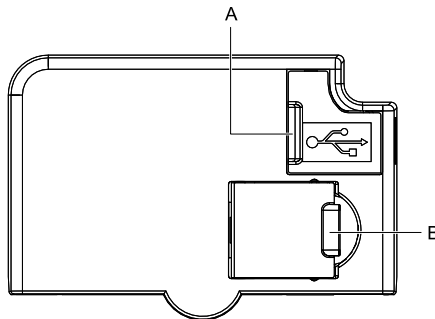

Figure 8.2 Blank Cover

Table 8.2 Blank Cover Components and Functions

Sym bol	Name	Function
A	USB Terminal Pass-through	Pass-through point to connect a USB cable to the drive to use the DriveWizard PC tool or the DriveWizard Mobile App to program the drive. Uses a USB cable (USB standard 2.0, type A - mini-B) to connect the drive to a PC, Android smartphone, or tablet.
B	RJ-45 Connector Pass-through	Connects to the drive. Use an RJ-45 8-pin straight UTP CAT5e extension cable to use the keypad option to program the drive.

◆ Keypad Mode and Menu Displays

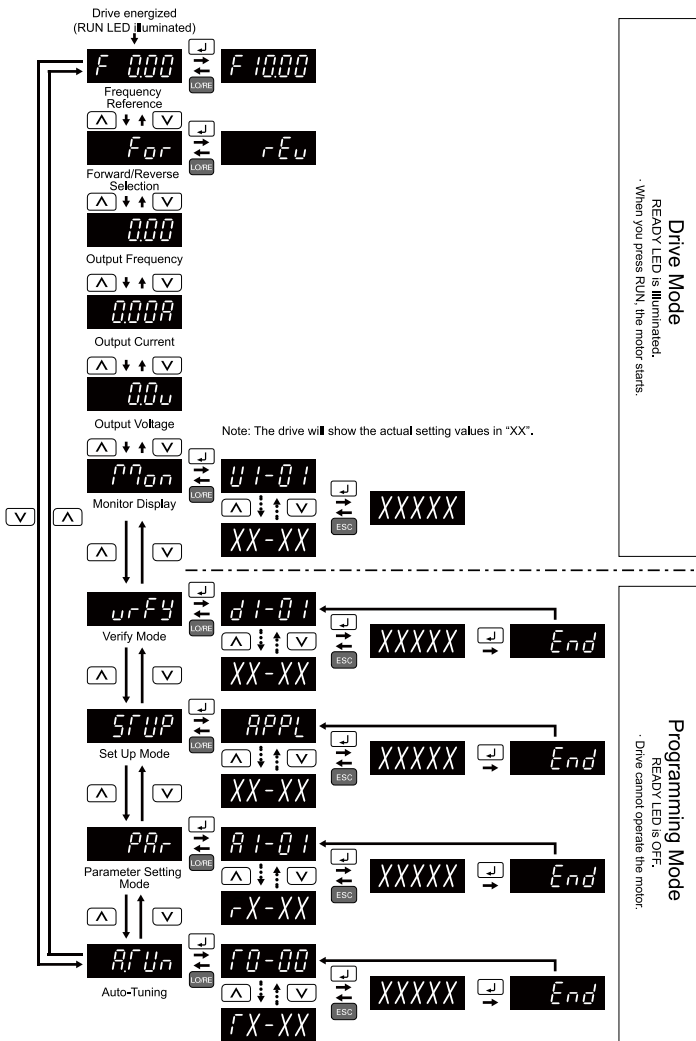

Figure 8.3 Keypad Functions and Display Levels

9 Mechanical Installation

This chapter gives information about the correct environment and clearances to install the drive.

◆ Drive Exterior and Mounting Dimensions

■ IP20/UL Open Type

B001 to B004, 2001 to 2006

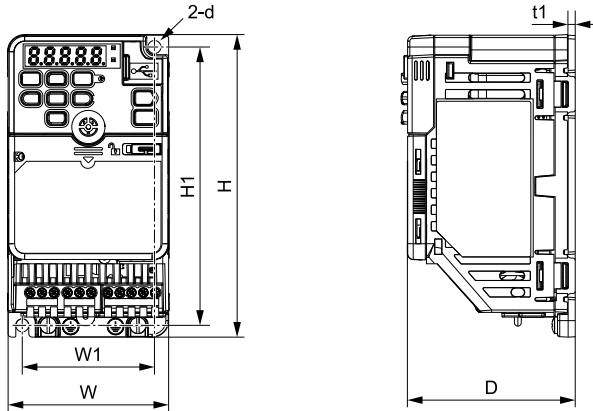

Figure 9.1 Exterior and Mounting Dimensions

Table 9.1 Single-Phase 200 V Class (Finless-Type Drive)

Model	Dimensions mm (in)							Est. Weight kg (lb)
	W	H	D	W1	H1	t1	d	
B001	68 (2.68)	128 (5.04)	71 (2.80)	56 (2.20)	118 (4.65)	3 (0.12)	M5	0.6 (1.32)
B002	68 (2.68)	128 (5.04)	71 (2.80)	56 (2.20)	118 (4.65)	3 (0.12)	M5	0.6 (1.32)
B004	68 (2.68)	128 (5.04)	81 (3.19)	56 (2.20)	118 (4.65)	3 (0.12)	M5	0.6 (1.32)

Table 9.2 Three-Phase 200 V Class (Finless-Type Drive)

Model	Dimensions mm (in)							Est. Weight kg (lb)
	W	H	D	W1	H1	t1	d	
2001	68 (2.68)	128 (5.04)	71 (2.80)	56 (2.20)	118 (4.65)	3 (0.12)	M5	0.6 (1.32)
2002	68 (2.68)	128 (5.04)	71 (2.80)	56 (2.20)	118 (4.65)	3 (0.12)	M5	0.6 (1.32)
2004	68 (2.68)	128 (5.04)	71 (2.80)	56 (2.20)	118 (4.65)	3 (0.12)	M5	0.6 (1.32)
2006	68 (2.68)	128 (5.04)	71 (2.80)	56 (2.20)	118 (4.65)	3 (0.12)	M5	0.6 (1.32)

B006 to B012, 2010 to 2021, 4001 to 4012**Figure 9.2 Exterior and Mounting Dimensions**

Table 9.3 Single-Phase 200 V Class (Finless-Type Drive)

Model	Dimensions mm (in)							Est. Weight kg (lb)
	W	H	D	W1	H1	t1	d	
B006	108 (4.25)	128 (5.04)	81 (3.19)	96 (3.78)	118 (4.65)	4 (0.16)	M5	0.9 (1.98)
B010	108 (4.25)	128 (5.04)	92.5 (3.64)	96 (3.78)	118 (4.65)	4 (0.16)	M5	1.0 (2.20)
B012	140 (5.51)	128 (5.04)	98 (3.86)	128 (5.04)	118 (4.65)	4 (0.16)	M5	1.2 (2.65)

Table 9.4 Three-Phase 200 V Class (Finless-Type Drive)

Model	Dimensions mm (in)							Est. Weight kg (lb)
	W	H	D	W1	H1	t1	d	
2010	108 (4.25)	128 (5.04)	72.5 (2.85)	96 (3.78)	118 (4.65)	4 (0.16)	M5	0.8 (1.76)
2012	108 (4.25)	128 (5.04)	81 (3.19)	96 (3.78)	118 (4.65)	4 (0.16)	M5	0.9 (1.98)
2021	140 (5.51)	128 (5.04)	78 (3.07)	128 (5.04)	118 (4.65)	4 (0.16)	M5	1.2 (2.65)

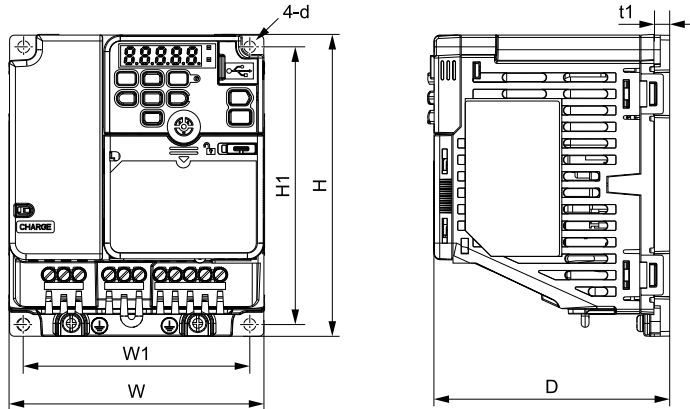
Table 9.5 Three-Phase 400 V Class (Finless-Type Drive)

Model	Dimensions mm (in)							Est. Weight kg (lb)
	W	H	D	W1	H1	t1	d	
4001	108 (4.25)	128 (5.04)	75 (2.95)	96 (3.78)	118 (4.65)	4 (0.16)	M5	0.8 (1.76)
4002	108 (4.25)	128 (5.04)	75 (2.95)	96 (3.78)	118 (4.65)	4 (0.16)	M5	0.8 (1.76)
4004	108 (4.25)	128 (5.04)	83.5 (3.29)	96 (3.78)	118 (4.65)	4 (0.16)	M5	0.9 (1.98)
4005	108 (4.25)	128 (5.04)	100 (3.94)	96 (3.78)	118 (4.65)	4 (0.16)	M5	1.0 (2.20)
4007	108 (4.25)	128 (5.04)	100 (3.94)	96 (3.78)	118 (4.65)	4 (0.16)	M5	1.0 (2.20)

Model	Dimensions mm (in)							Est. Weight kg (lb)
	W	H	D	W1	H1	t1	d	
4009	108 (4.25)	128 (5.04)	100 (3.94)	96 (3.78)	118 (4.65)	4 (0.16)	M5	1.0 (2.20)
4012	140 (5.51)	128 (5.04)	78 (3.07)	128 (5.04)	118 (4.65)	4 (0.16)	M5	1.2 (2.65)

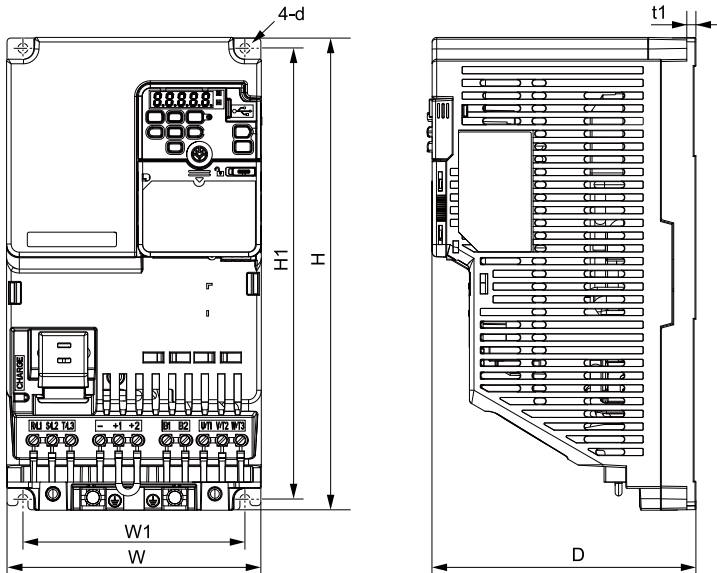
2030 - 2070, 4018 - 4038**Figure 9.3 Exterior and Mounting Dimensions****Table 9.6 Three-Phase 200 V Class (Finless-Type Drive)**

Model	Dimensions mm (in)							Est. Weight kg (lb)
	W	H	D	W1	H1	t1	d	
2030	140 (5.51)	260 (10.24)	145 (5.71)	122 (4.80)	248 (9.76)	5 (0.20)	M5	2.9 (6.39)
2042	140 (5.51)	260 (10.24)	145 (5.71)	122 (4.80)	248 (9.76)	5 (0.20)	M5	3.1 (6.83)

Model	Dimensions mm (in)							Est. Weight kg (lb)
	W	H	D	W1	H1	t1	d	
2056	180 (7.09)	300 (11.81)	147 (5.79)	160 (6.30)	284 (11.18)	5 (0.20)	M5	4.5 (9.92)
2070	220 (8.66)	350 (13.78)	152 (5.98)	192 (7.56)	336 (13.23)	5 (0.20)	M6	6.0 (13.23)

Table 9.7 Three-Phase 400 V Class (Finless-Type Drive)

Model	Dimensions mm (in)							Est. Weight kg (lb)
	W	H	D	W1	H1	t1	d	
4018	140 (5.51)	260 (10.24)	145 (5.71)	122 (4.80)	248 (9.76)	5 (0.20)	M5	2.6 (5.73)
4023	140 (5.51)	260 (10.24)	145 (5.71)	122 (4.80)	248 (9.76)	5 (0.20)	M5	2.8 (6.17)
4031	180 (7.09)	300 (11.81)	147 (5.79)	160 (6.30)	284 (11.18)	5 (0.20)	M5	4.1 (9.04)
4038	180 (7.09)	300 (11.81)	147 (5.79)	160 (6.30)	284 (11.18)	5 (0.20)	M5	4.3 (9.48)

◆ **Installation Position and Clearances**

Install the drive as shown in [Figure 9.4](#) for sufficient airflow to cool the drive.

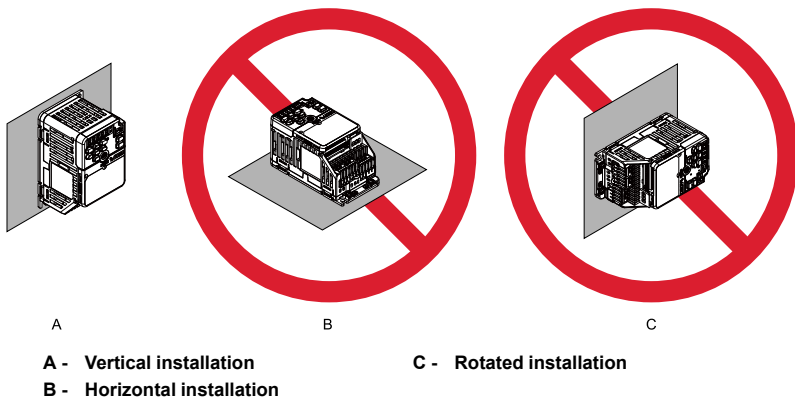

Figure 9.4 Installation Orientation

Use the clearances specified in [Figure 9.5](#) to install the drive. Make sure that there is sufficient space for wiring and airflow.

Tightly push the drive heatsink plate against the metal surface (enclosure panel) for correct thermal transfer between the drive and the metal surface.

Note:

You cannot install finless-type drives side-by-side.

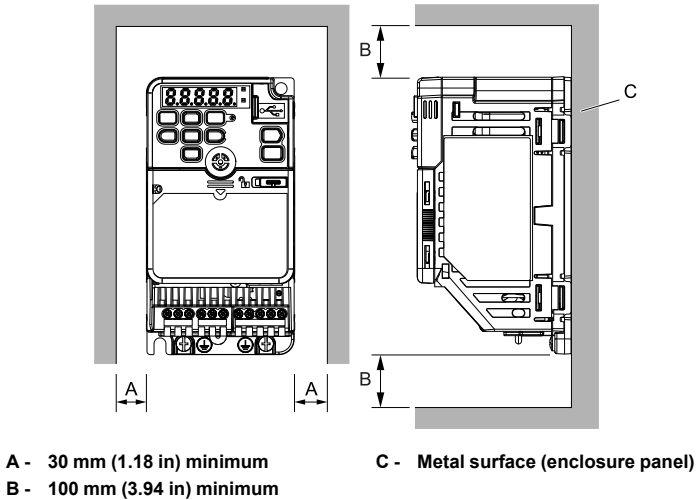

Figure 9.5 Installation Clearances

◆ External Heatsink Selection

This section gives information about how to select an applicable external heatsink.

■ Necessary Data for External Heatsink Selection

Symbol	Description
P_{Loss}	Drive heatsink watt loss (W) *1
T_{HSP_max}	<p>Maximum heatsink plate temperature This is the temperature at the surface of the heatsink plate. Set U4-08 [Heatsink Temperature] to monitor the drive heatsink temperature. Maximum temperatures are different for different models.</p> <ul style="list-style-type: none"> • B001 - B012: 90 °C (194 °F) • 2001 - 2021: 90 °C (194 °F) • 2030 - 2070: 80 °C (176 °F) • 4001 - 4012: 90 °C (194 °F) • 4018 - 4038: 80 °C (176 °F)
T_{Amb}	Ambient temperature of the external heatsink
$R\theta_{HSP}$	<p>Drive heatsink plate thermal resistance This value is 0.05 K/W.</p>
$R\theta_{HSP-EHS}$	<p>You can use the formula to calculate thermal resistance between the drive heatsink plate and the external heatsink.</p> $R\theta_{HSP-EHS} = \frac{d_{Comp}}{\lambda_{Comp} \cdot A_{th}}$
	<p>A_{th} Heat transfer area between drive heatsink plate and external heatsink Note: Heat generation across the drive heatsink plate is not equal because of the arrangement of internal components. The effective area for thermal transfer is only 70% of the drive heatsink plate area. Use the H and W values of the drive exterior dimensions *2 to calculate the area of the drive heatsink plate.</p>
	<p>λ_{Comp} Thermal transfer rate of the thermal compound</p>
	<p>d_{Comp} Thickness of the thermal compound (when applied)</p>
$R\theta_{EHS}$	Thermal Resistance of the external heatsink

*1 Refer to *Drive Watt Loss on page 25* for information.

*2 Refer to *Drive Exterior and Mounting Dimensions on page 40* for information.

External Heatsink Selection Methods

Keep the drive heatsink plate temperature lower than the maximum temperature in all ambient temperatures. Select an applicable external heatsink for your application.

Figure 9.6 shows the thermal transfer principle from the drive heatsink plate to the ambient air of the external heatsink.

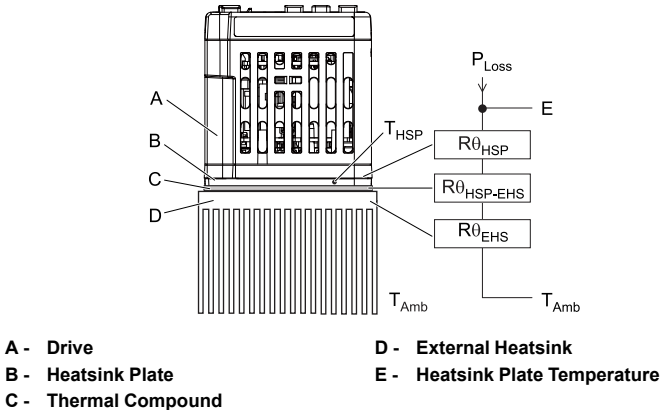

Figure 9.6 Thermal Equivalent Circuit Diagram

Select External Heatsink by Thermal Resistance

Use the formula to calculate the maximum thermal resistance $R\theta_{EHS_max}$ of the external heatsink.

$$R\theta_{EHS_max} = \left(\frac{T_{HSP_max} - T_{Amb}}{P_{Loss}} - R\theta_{HSP} - R\theta_{HSP-EHS} \right)$$

Select an external heatsink with a smaller thermal resistance than $R\theta_{EHS_max}$.

Make sure that the dimensions of the external heatsink are close to the drive dimensions ($H \times W$). If the thermal resistance of the external heatsink is large, but the dimensions of the external heatsink are near the external dimensions of the drive, select one of these external heatsinks:

- External heatsink with more fins
- External heatsink with longer fin shape

Consider the installation environment of the drive and correct the thermal resistance $R\theta_{EHS}$ of the external heatsink. Dust and unwanted material can decrease the cooling capacity of the external heatsink.

Note:

Apply correction factors to the thermal resistance values listed in the specification of the external heatsink in these cases. For details, contact the external heatsink manufacturer.

- The heatsink height and width dimensions are much larger than the drive heatsink plate dimensions.
- When you install multiple drives on one heatsink.

Examine Feasibility of the Selected External Heatsink

When you select an external heatsink, if installation conditions, for example installation space, limit your selection, use the formula to calculate the heatsink plate temperature and examine the external heatsink.

$$T_{HSP} = P_{Loss} \cdot (R\theta_{HSP} + R\theta_{HSP-EHS} + R\theta_{EHS}) + T_{Amb}$$

If T_{HSP} value is lower than the maximum temperature of the heatsink, you can use the selected external heatsink.

Refer to *Monitor Heatsink Plate Temperature on page 23* to monitor drive heatsink plate temperature.

External Heatsink Selection

The examples show applicable heatsink selection for drive model 2006 when $C6-01 = 1$ [*Normal / Heavy Duty Selection = Normal Duty Rating*].

These are examples of calculations for the external heatsink from MIZUTANI ELECTRIC IND.CO., LTD.

- Universal Type Heat Sink EF Series, EF (98) L:150 (thermal resistance $R\theta_{EHS} = 1.6$ K/W)
- Universal Type Heat Sink EK Series, EK (95) L:150 (thermal resistance $R\theta_{EHS} = 1.1$ K/W)

Table 9.8 External Heatsink Selection

Symbol	Value
P_{Loss}	25.0 W
T_{HSP_max}	90 °C (194 °F)
T_{Amb}	40 °C (104 °F)
$R\theta_{HSP}$	0.05 K/W

Symbol	Value	
$R\theta_{\text{HSP-EHS}}$	A_{th}	H = 128 mm D = 68 mm $A_{\text{th}} = 0.7 \times 0.128 \text{ m} \times 0.068 \text{ m} = 6.1 \times 10^{-3} \text{ m}^2$
	λ_{Comp}	2.0 W/(m·K) Thermal conductivity of Oil-based compound X-23-7795 from Shin-Etsu Chemical Co., Ltd.
	d_{Comp}	100 μm Recommended compound thickness (when applied)
	$R\theta_{\text{HSP-EHS}} = \frac{100 \mu\text{m}}{2.0 \text{ W}/(\text{m}\cdot\text{K}) \times 6.1 \times 10^{-3} \text{ m}^2} = 0.008 \text{ K/W}$	

Select External Heatsink by Thermal Resistance

Replace the value of [Table 9.8](#) into the formula in [Select External Heatsink by Thermal Resistance on page 47](#).

$$R\theta_{\text{EHS_max}} = \left(\frac{90 \text{ }^\circ\text{C} - 40 \text{ }^\circ\text{C}}{25.0 \text{ W}} - 0.05 \text{ K/W} - 0.008 \text{ K/W} \right) = 1.94 \text{ K/W}$$

The thermal resistance of the external heatsink “EF(98) L: 150” is 1.6 K/W, so you can use it. Yaskawa recommends the external heatsink “EK (95) L: 150” to prevent overheat if there is a temporary temperature increase or a decrease in the cooling capacity of the external heatsink because of dust and unwanted material.

Examine Feasibility of the Selected External Heatsink

The thermal resistance of the external heatsink “EF (98) L: 150” is 1.6 K/W. You can use the formula to calculate the heatsink plate temperature.

$$T_{\text{HSP}} = 25.0 \text{ W} \cdot (0.05 \text{ K/W} + 0.008 \text{ K/W} + 1.6 \text{ K/W}) + 40 \text{ }^\circ\text{C} = 81.45 \text{ }^\circ\text{C}$$

The temperature of the heatsink plate is lower than the maximum value of 90 °C, so you can use it. Because the thermal transfer area is 70% of the drive mounting area, and the environmental conditions can change because dust and unwanted material can decrease the cooling capacity of the external heatsink, Yaskawa recommends “EK (95) L: 150” heatsink to achieve $R\theta_{\text{EHS}} = 1.1 \text{ K/W}$ ($T_{\text{HSP}} = 68.95 \text{ }^\circ\text{C}$).

◆ Removing/Reattaching Covers

▲ DANGER *Electrical Shock Hazard. Do not examine, connect, or disconnect wiring on an energized drive. Before servicing, disconnect all power to the equipment and wait for the time specified on the warning label at a minimum. The internal capacitor stays charged after the drive is de-energized. The charge indicator LED extinguishes when the DC bus voltage decreases below 50 Vdc. When all indicators are OFF, measure for dangerous voltages to make sure that the drive is safe. If you do work on the drive when it is energized, it will cause serious injury or death from electrical shock.*

■ Remove the Front Cover

1. Use a slotted screwdriver to unlock the front cover of the drive.
Use a slotted screwdriver with a tip width of 2.5 mm (0.1 in) or less and a thickness of 0.4 mm (0.02 in) or less.

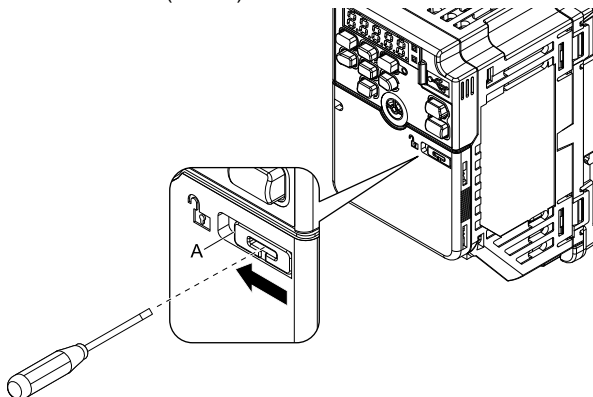

A - Front cover lock

Figure 9.7 Unlocking

2. Pull down, then pull away from the drive to remove the front cover.

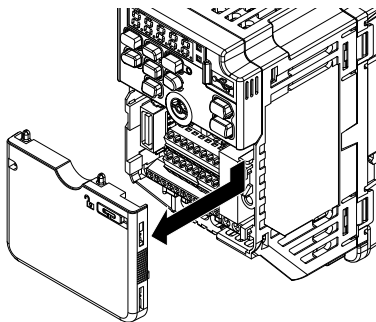

Figure 9.8 Remove the Front Cover

■ Reattach the Front Cover

1. Reverse the steps to reattach the cover.

Note:

Make sure that you do not pinch wires or signal lines between the front cover and the drive before you reattach the cover.

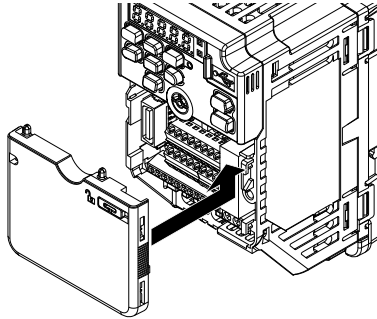
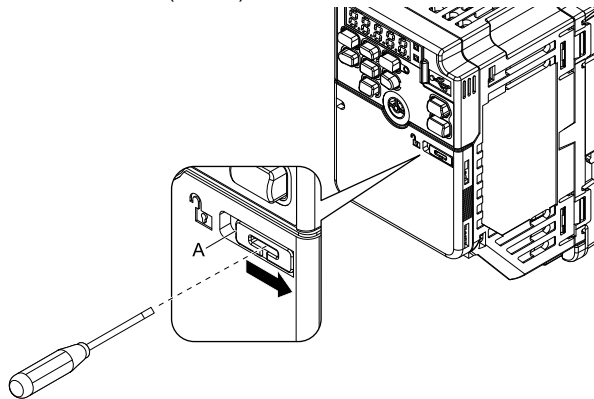

Figure 9.9 Reattach the Front Cover

2. Use a slotted screwdriver to lock the front cover of the drive.

Use a slotted screwdriver with a tip width of 2.5 mm (0.1 in) or less and a thickness of 0.4 mm (0.02 in) or less.



A - Front cover lock

Figure 9.10 Locking the Front Cover

10 Electrical Installation

⚠ DANGER *Electrical Shock Hazard. Do not examine, connect, or disconnect wiring on an energized drive. Before servicing, disconnect all power to the equipment and wait for the time specified on the warning label at a minimum. The internal capacitor stays charged after the drive is de-energized. The charge indicator LED extinguishes when the DC bus voltage decreases below 50 Vdc. When all indicators are OFF, measure for dangerous voltages to make sure that the drive is safe. If you do work on the drive when it is energized, it will cause serious injury or death from electrical shock.*

⚠ WARNING *Electrical Shock Hazard. De-energize the drive and wait 5 minutes minimum until the Charge LED turns off. Remove the front cover and terminal cover to do work on wiring, circuit boards, and other parts. Use terminals for their correct function only. Incorrect wiring, incorrect ground connections, and incorrect repair of protective covers can cause death or serious injury.*

⚠ WARNING *Electrical Shock Hazard. Use the terminals for the drive only for their intended purpose. Refer to the technical manual for more information about the I/O terminals. Wiring and grounding incorrectly or modifying the cover may damage the equipment or cause injury.*

◆ Standard Connection Diagram

Wire the drive as specified by [Figure 10.1](#).

⚠ WARNING *Sudden Movement Hazard. Set the MFDI parameters before you close control circuit switches. Incorrect Run/Stop circuit sequence settings can cause serious injury or death from moving equipment.*

⚠ WARNING *Sudden Movement Hazard. Correctly wire the start/stop and safety circuits before you energize the drive. If you momentarily close a digital input terminal, it can start a drive that is programmed for 3-Wire control and cause serious injury or death from moving equipment.*

⚠ WARNING *Sudden Movement Hazard. When you use a 3-Wire sequence, set A1-03 = 3330 [Initialize Parameters = 3-Wire Initialization] and make sure that b1-17 = 0 [Run Command at Power Up = Disregard Existing RUN Command] (default). If you do not correctly set the drive parameters for 3-Wire operation before you energize the drive, the motor can suddenly rotate when you energize the drive.*

⚠ WARNING *Sudden Movement Hazard. Check the I/O signals and the external sequences for the drive before you set the Application Preset function. When you set the Application Preset function (A1-06 ≠ 0), it changes the I/O terminal functions for the drive and it can cause equipment to operate unusually. This can cause serious injury or death.*

NOTICE *Fire Hazard. Install sufficient branch circuit short circuit protection as specified by applicable codes and this manual. The drive is suitable for circuits that supply not more than 31,000 RMS symmetrical amperes, 240 Vac maximum (200 V Class), 480 Vac maximum (400 V Class). Incorrect branch circuit short circuit protection can cause serious injury or death.*

NOTICE *When the input voltage is 440 V or higher or the wiring distance is longer than 100 m (328 ft), make sure that the motor insulation voltage is sufficient or use an inverter-duty motor or vector-duty motor with reinforced insulation. Motor winding and insulation failure can occur.*

Note:

Do not connect the AC control circuit ground to the drive enclosure. Failure to obey can cause incorrect control circuit operation.

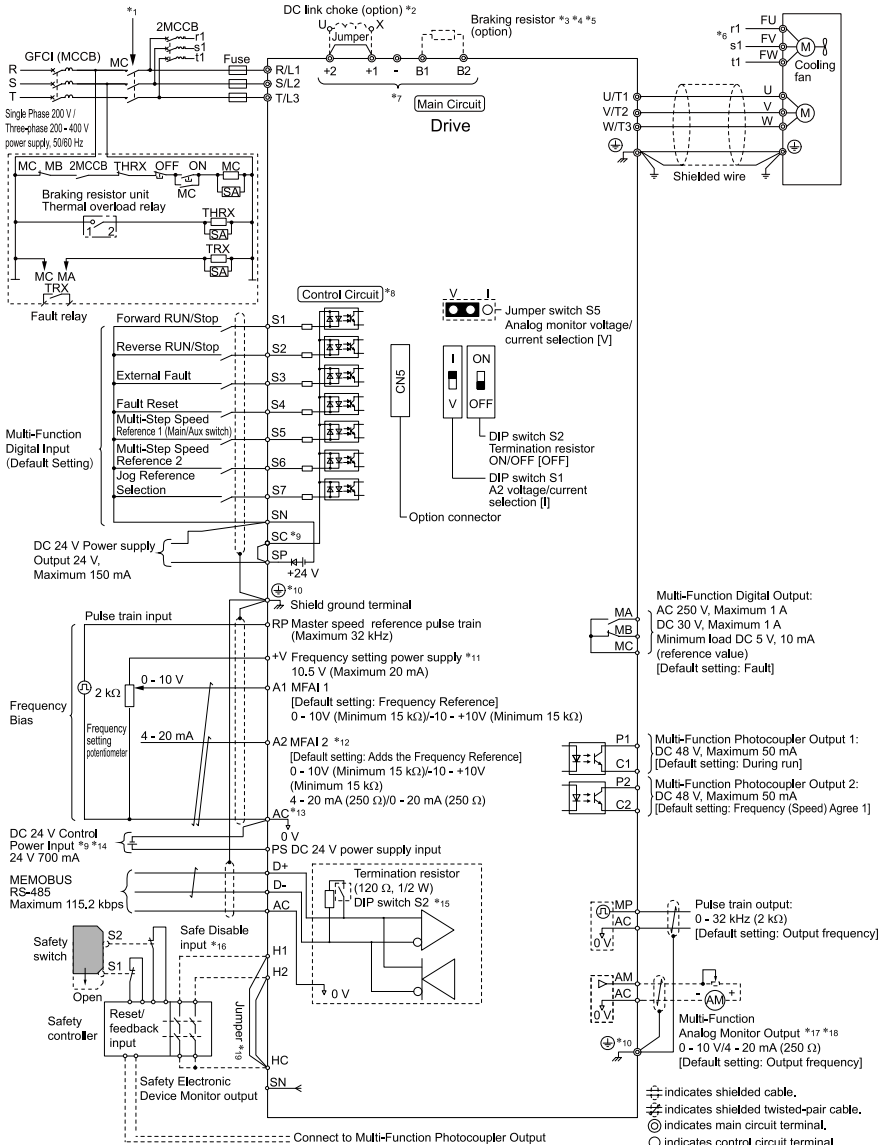

Figure 10.1 Standard Drive Connection Diagram

- *1 Set the wiring sequence to de-energize the drive with the MFDO. If the drive outputs a fault during fault restart when you use the fault restart function, set $L5-02 = 1$ [*Fault Contact at Restart Select = Always Active*] to de-energize the drive. Be careful when you use a cut-off sequence. The default setting for $L5-02$ is 0 [*Active Only when Not Restarting*].
- *2 When you install a DC link choke, you must remove the jumper between terminals +1 and +2.
- *3 When you use a regenerative converter or regenerative unit, set $L8-55 = 0$ [*Internal DB Transistor Protection = Disable*]. If $L8-55 = 1$ [*Protection Enabled*], the drive will detect rF [*Braking Resistor Fault*].
- *4 When you use a regenerative converter, regenerative unit, braking resistor, or braking resistor unit, set $L3-04 = 0$ [*Stall Prevention during Decel = Disabled*]. If $L3-04 = 1$ [*General Purpose*], the drive could possibly not stop in the specified deceleration time.
- *5 When you use an ERF-type braking resistor, set $L8-01 = 1$ [*3% ERF DB Resistor Protection = Enabled*] and set a wiring sequence to de-energize the drive with the MFDO.
- *6 Cooling fan wiring is not necessary for self-cooling motors.
- *7 Connect peripheral options to terminals -, +1, +2, B1, and B2.

⚠ WARNING *Fire Hazard. Only connect factory-recommended devices or circuits to drive terminals B1, B2, -, +1, and +2. Do not connect an AC power supply lines to these terminals. Incorrect wiring can cause damage to the drive and serious injury or death from fire.*

- *8 Connect a 24 V power supply to terminals PS-AC to operate the control circuit while the main circuit power supply is OFF.
- *9 To set the MFDI power supply (Sinking/Sourcing Mode or internal/external power supply), install or remove a jumper between terminals SC-SP or SC-SN depending on the application.

NOTICE *Damage to Equipment. Do not close the circuit between terminals SP-SN. If you close the circuits between terminals SC-SP and terminals SC-SN at the same time, it will cause damage to the drive.*

- Sinking Mode, Internal power supply: Install the jumper to close the circuit between terminals SC-SP.

NOTICE *Damage to Equipment. Do not close the circuit between terminals SC-SN. If you close the circuits between terminals SC-SP and terminals SC-SN at the same time, it will cause damage to the drive.*

- Sourcing Mode, Internal power supply: Install the jumper to close the circuit between terminals SC-SN.

NOTICE *Damage to Equipment. Do not close the circuit between terminals SC-SP. If you close the circuits between terminals SC-SP and terminals SC-SN at the same time, it will cause damage to the drive.*

- External power supply: Remove the jumper from the MFDI terminals. It is not necessary to close the circuit between terminals SC-SP and terminals SC-SN.

- *10 **⚠ WARNING** *Electrical Shock Hazard. Do not ground the shield of the control wiring to the protective ground terminal. It does not comply with technical standards and local codes and can cause serious injury or death.*

- *11 The maximum output current capacity for terminal +V on the control circuit is 20 mA.

NOTICE *Damage to Equipment. Do not install a jumper between terminals +V and AC. A closed circuit between these terminals will cause damage to the drive.*

- *12 DIP switch S1 sets terminal A2 for voltage or current input. The default setting for S1 is current input ("I" side).

- *13 Do not ground the control circuit terminals AC or connect them to the drive chassis.

NOTICE Do not ground the AC control circuit terminals and only connect the AC terminals according to the product instructions. If you connect the AC terminals incorrectly, it can cause damage to the drive.

- *14 Connect the positive lead from an external 24 Vdc power supply to terminal PS and the negative lead to terminal AC.

NOTICE Connect terminals PS and AC correctly for the 24 V power supply. If you connect the wires to the incorrect terminals, it will cause damage to the drive.

- *15 Set DIP switch S2 to "ON" to enable the termination resistor in the last drive in a MEMOBUS/Modbus network.
- *16 Use only Sourcing Mode for Safe Disable input.
- *17 Use multi-function analog monitor outputs with analog frequency meters, ammeters, voltmeters, and wattmeters. Do not use monitor outputs with feedback-type signal devices.
- *18 Jumper S5 sets terminal AM for voltage or current output. The default setting for S5 is voltage output ("V" side).
- *19 Disconnect the wire jumpers between H1 and HC and H2 and HC to use the Safe Disable input.

◆ Main Circuit Terminal Block Wiring Procedure

⚠ DANGER Electrical Shock Hazard. Do not examine, connect, or disconnect wiring on an energized drive. Before servicing, disconnect all power to the equipment and wait for the time specified on the warning label at a minimum. The internal capacitor stays charged after the drive is de-energized. The charge indicator LED extinguishes when the DC bus voltage decreases below 50 Vdc. When all indicators are OFF, measure for dangerous voltages to make sure that the drive is safe. If you do work on the drive when it is energized, it will cause serious injury or death from electrical shock.

■ Wire to the Main Circuit Terminal Block

Wire to the main circuit terminal block correctly as specified by the instructions in the manual.

Read these instructions before wiring the terminal block.

Notes on Wiring the Main Circuit Terminal Block

Read these notes before you wire the main circuit terminal block.

- Use UL-Listed, vinyl-coated insulated copper wires for operation with a continuous maximum permitted temperature of 75 °C at 600 V.
- Remove all unwanted objects that are near the terminal block connections.
- Remove the insulation from the connection wires to the wire stripping lengths shown in the manual.
- Do not use bent or crushed wires. Remove the damaged end of the wire before you use it. Incorrect connections can cause death or serious injury from fire.
- Do not solder stranded wire. Soldered wire connections can become loose over time and cause unsatisfactory drive performance.
- If you use stranded wire, make sure that all of the wire strands are in the connection. Also, do not twist the stranded wire too much. Incorrect connections can cause death or serious injury from fire.

- Put the wire all the way into the terminal block. Remove the insulation from the wire to the recommended wire stripping length to fit the wire with insulation in the plastic housing.
- Use a torque driver, torque ratchet, or torque wrench for the screws. A slotted driver or a hex tool will be necessary to wire the screw clamp terminal. Use applicable tools as specified by the recommended conditions in the product manual.
- If you use power tools to tighten the terminal screws, use a low speed setting (300 to 400 r/min). Failure to obey can cause damage to the terminal screws.
- Users can purchase wiring tools from Yaskawa. Contact Yaskawa or your nearest sales representative for more information.
- Wire gauges on existing drive models to be replaced may not match wire gauge ranges on new drives. Contact Yaskawa or your nearest sales representative for more information about the connection procedures.
- Do not tighten the terminal screws at an angle of 5 degrees or more. Failure to obey can cause damage to the terminal screws. If you damage a terminal screw, contact Yaskawa or your nearest sales representative.

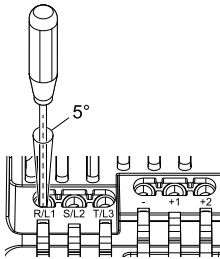

Figure 10.2 Permitted Angle

- Put the bit all the way into the hex socket to tighten the hex socket cap screw.
- When you tighten slotted screws, hold the straight-edge screwdriver perpendicularly to the screw. Make sure that you align the end of the straight-edge screwdriver with the screw groove.

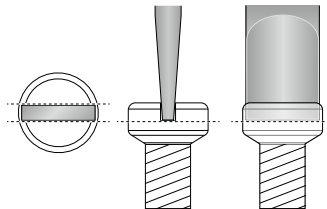
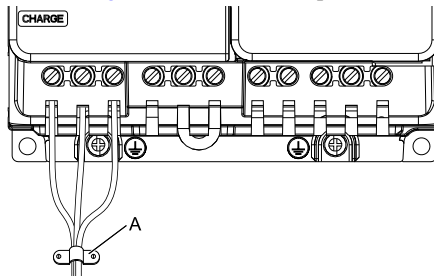

Figure 10.3 Tightening Slotted Screws

- After you connect the wires to the terminal block, lightly pull on the wires to make sure that they do not come out of the terminals.
- Do not let strain on the wiring cause damage. Use a strain relief near the wiring to release the tension. Refer to [Figure 10.4](#) for an example.



A - Cable clamp

Figure 10.4 Strain Relief Example

Table 10.1 Recommended Wiring Tools

Screw Size	Screw Shape	Wire Gauge	Adapter	Bit		Torque Driver Model (Tightening Torque)	Torque Wrench (Tightening Torque)
				Model	Manufacturer		
M3	⊖	-	Bit	SF-BIT-SL 0,5X3,0-70	PHOENIX CONTACT	TSD-M 1,2NM (0.3 - 1.2 N·m (2.7 - 10.6 lbf·in))	-
M4	⊖	-	Bit	SF-BIT-SL 1,0X4,0-70	PHOENIX CONTACT	TSD-M 3NM (1.2 - 3.0 N·m (10.6 - 26.6 lbf·in))	-
M5 *1	⊖	≤ 25 mm ² (AWG 10)	Bit	SF-BIT-SL 1,2X6,5-70	PHOENIX CONTACT	TSD-M 3NM (1.2 - 3.0 N·m (10.6 - 26.6 lbf·in))	-
		≥ 30 mm ² (AWG 8)				-	
M6	⊕ (WAF: 5 mm)	-	Bit	SF-BIT-HEX 5-50	PHOENIX CONTACT	-	5 - 9 N·m (44.3 - 79.7 lbf·in) *2 *3

*1 When you wire drive models 2042, 2056, 4031, and 4038, select the correct tools for the wire gauge.

- *2 Use 6.35 mm (0.25 in) bit socket holder.
- *3 Use a torque wrench that can apply this torque measurement range.

Remove IP20 Terminal Protective Cover

Remove the IP20 terminal protective cover for the application.

1. Put a slotted screwdriver blade into the slit to push the hook of the IP20 terminal protective cover.

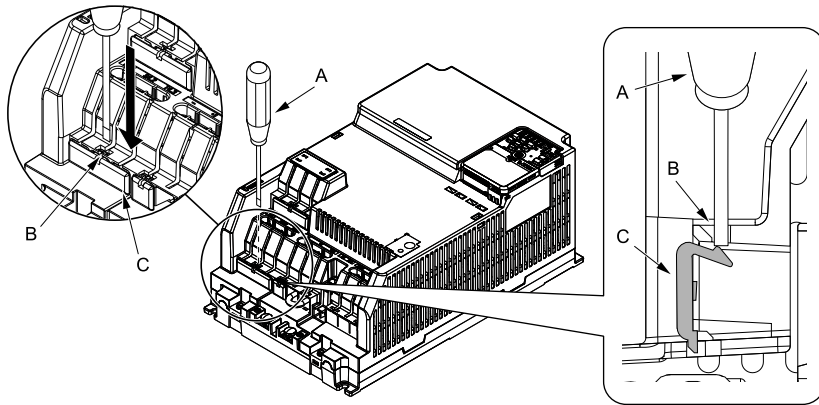

A - Slotted screwdriver
B - Slit

C - IP20 terminal protective cover

Figure 10.5 Put the Screwdriver Blade into the Slit

2. Push up the screwdriver to release the IP20 terminal protective cover.

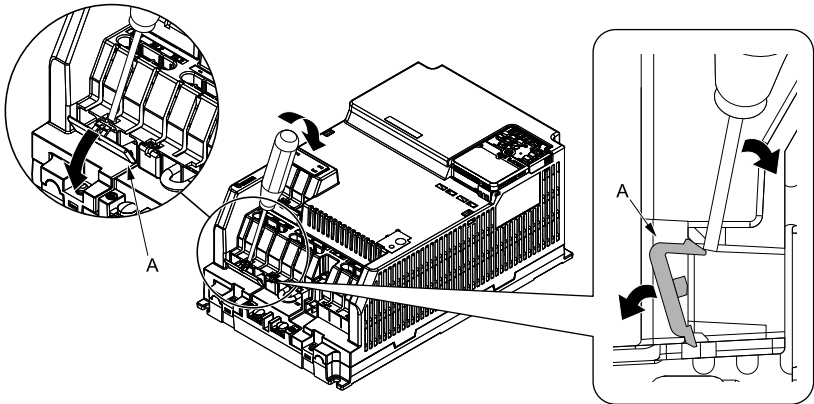

A - IP20 terminal protective cover

Figure 10.6 Release IP20 Terminal Protective Cover

3. Remove IP20 terminal protective cover.

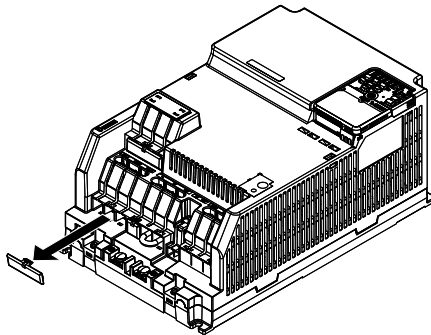

Figure 10.7 Remove IP20 Terminal Protective Cover

Main Circuit Terminal Block Wiring Procedure

When terminals R/L1, S/L2, T/L3, and terminal - have IP20 terminal protective covers, remove the cover on the terminal where you will wire.

1. Put wires with prepared ends into the main circuit terminal block.
Look through the opening in the drive case to make sure that you correctly installed the wires into the terminal block.

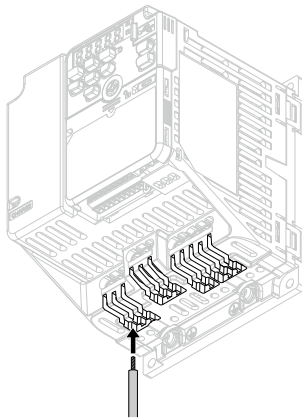

Figure 10.8 Install the Electrical Wire

Note:

There is a jumper between terminals +1 and +2. Remove the jumper, then wire to terminals +1 and +2.

2. Tighten the screws to the specified torque.

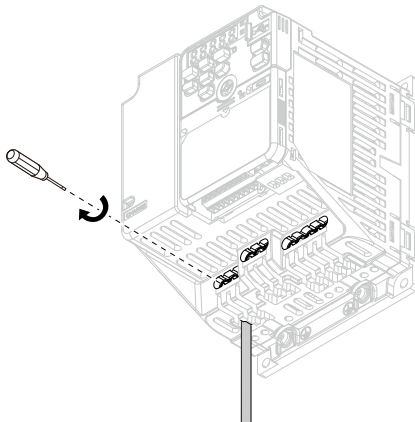



Figure 10.9 Tighten Terminal Block Screws

◆ Main Circuit Terminal Functions

Refer to [Table 10.2](#) for the functions of drive main circuit terminals.

Table 10.2 Main Circuit Terminal Functions

Terminal	Name			Function
Model	B001 - B012	2001 - 2070		
		4001 - 4038		
R/L1	-	Main circuit power supply input		To connect a commercial power supply.
S/L2				
T/L3				
L/L1	Main circuit power supply input	-		
N/L2				
U/T1	Drive output	Drive output		
V/T2				
W/T3				
-	DC power input	DC power input	-	+1 and +2: To connect a DC link choke. Note: Remove the jumper between terminals +1 and +2 to connect a DC link choke.
+1				
+2		-	-	
B1	Braking resistor connection			To connect a braking resistor or braking resistor unit.
B2				
	Ground Wiring			To ground the drive. <ul style="list-style-type: none"> • 200 V: D class grounding (ground to 100 Ω or less) • 400 V: C class grounding (ground to 10 Ω or less)

◆ Wire Selection



Select the correct wires for main circuit wiring.

Refer to *Main Circuit Wire Gauges and Tightening Torques on page 175* for wire gauges and tightening torques as specified by European standards.



















Refer to *Main Circuit Wire Gauges and Tightening Torques on page 197* for wire gauges and tightening torques as specified by UL standards.

These tables use icons in [Table 10.3](#) to show the shapes of the screw heads.

Table 10.3 Icons to Identify Screw Shapes

Icon	Screw Shape
	Phillips/slot combo (+/-)
	Slotted (-)
	Hex socket cap (WAF: 5 mm)



















■ Single-Phase 200 V Class

Model	Terminal	Recomm. Gauge AWG, kcmil	Applicable Gauge AWG, kcmil	Wire Stripping Length mm	Terminal Screw Size and Shape	Tightening Torque N·m (lbf·in)
B001	L/L1, N/L2	14	14	6.5	M3 	0.5 - 0.6 (4.4 - 5.3)
	U/T1, V/T2, W/T3	14	14	6.5	M3 	0.5 - 0.6 (4.4 - 5.3)
	-, +1	14	14	6.5	M3 	0.5 - 0.6 (4.4 - 5.3)
	B1, B2	14	14	6.5	M3 	0.5 - 0.6 (4.4 - 5.3)
		14	14	-	M3.5 	0.8 - 1.0 (7.1 - 8.9)
B002	L/L1, N/L2	14	14	6.5	M3 	0.5 - 0.6 (4.4 - 5.3)
	U/T1, V/T2, W/T3	14	14	6.5	M3 	0.5 - 0.6 (4.4 - 5.3)
	-, +1	14	14	6.5	M3 	0.5 - 0.6 (4.4 - 5.3)
	B1, B2	14	14	6.5	M3 	0.5 - 0.6 (4.4 - 5.3)
		14	14	-	M3.5 	0.8 - 1.0 (7.1 - 8.9)
B004	L/L1, N/L2	14	14	6.5	M3 	0.5 - 0.6 (4.4 - 5.3)
	U/T1, V/T2, W/T3	14	14	6.5	M3 	0.5 - 0.6 (4.4 - 5.3)
	-, +1	14	14	6.5	M3 	0.5 - 0.6 (4.4 - 5.3)
	B1, B2	14	14	6.5	M3 	0.5 - 0.6 (4.4 - 5.3)
		14	14	-	M3.5 	0.8 - 1.0 (7.1 - 8.9)

Model	Terminal	Recomm. Gauge AWG, kcmil	Applicable Gauge AWG, kcmil	Wire Stripping Length *1 mm	Terminal Screw Size and Shape	Tightening Torque N·m (lbf·in)
B006	L/L1, N/L2	12	14 - 10	8	M3 ⊖	0.5 - 0.6 (4.4 - 5.3)
	U/T1, V/T2, W/T3	14	14 - 12	8	M3 ⊖	0.5 - 0.6 (4.4 - 5.3)
	-, +1	12	14 - 10	8	M3 ⊖	0.5 - 0.6 (4.4 - 5.3)
	B1, B2	14	14 - 12	8	M3 ⊖	0.5 - 0.6 (4.4 - 5.3)
	⊕	10	14 - 10	-	M4 ⊕	1.2 - 1.5 (10.6 - 13.3)
B010	L/L1, N/L2	10	12 - 10	8	M3 ⊖	0.5 - 0.6 (4.4 - 5.3)
	U/T1, V/T2, W/T3	14	14 - 12	8	M3 ⊖	0.5 - 0.6 (4.4 - 5.3)
	-, +1	10	12 - 10	8	M3 ⊖	0.5 - 0.6 (4.4 - 5.3)
	B1, B2	14	14 - 12	8	M3 ⊖	0.5 - 0.6 (4.4 - 5.3)
	⊕	10	14 - 10	-	M4 ⊕	1.2 - 1.5 (10.6 - 13.3)
B012	L/L1, N/L2	8	14 - 8	10	M4 ⊖	1.5 - 1.7 (13.5 - 15)
	U/T1, V/T2, W/T3	12	14 - 10	10	M4 ⊖	1.5 - 1.7 (13.5 - 15)
	-, +1	8	14 - 8	10	M4 ⊖	1.5 - 1.7 (13.5 - 15)
	B1, B2	14	14 - 12	10	M4 ⊖	1.5 - 1.7 (13.5 - 15)
	⊕	10	14 - 10	-	M4 ⊕	1.2 - 1.5 (10.6 - 13.3)













*1 Remove insulation from the ends of wires to expose the length of wire shown.

■ Three-Phase 200 V Class

Model	Terminal	Recomm. Gauge AWG, kcmil	Applicable Gauge AWG, kcmil	Wire Stripping Length mm	Terminal Screw Size and Shape	Tightening Torque N·m (lbf·in)
2001	R/L1, S/L2, T/L3	14	14	6.5	M3 	0.5 - 0.6 (4.4 - 5.3)
	U/T1, V/T2, W/T3	14	14	6.5	M3 	0.5 - 0.6 (4.4 - 5.3)
	-, +1, +2	14	14	6.5	M3 	0.5 - 0.6 (4.4 - 5.3)
	B1, B2	14	14	6.5	M3 	0.5 - 0.6 (4.4 - 5.3)
		14	14	-	M3.5 	0.8 - 1.0 (7.1 - 8.9)
2002	R/L1, S/L2, T/L3	14	14	6.5	M3 	0.5 - 0.6 (4.4 - 5.3)
	U/T1, V/T2, W/T3	14	14	6.5	M3 	0.5 - 0.6 (4.4 - 5.3)
	-, +1, +2	14	14	6.5	M3 	0.5 - 0.6 (4.4 - 5.3)
	B1, B2	14	14	6.5	M3 	0.5 - 0.6 (4.4 - 5.3)
		14	14	-	M3.5 	0.8 - 1.0 (7.1 - 8.9)
2004	R/L1, S/L2, T/L3	14	14	6.5	M3 	0.5 - 0.6 (4.4 - 5.3)
	U/T1, V/T2, W/T3	14	14	6.5	M3 	0.5 - 0.6 (4.4 - 5.3)
	-, +1, +2	14	14	6.5	M3 	0.5 - 0.6 (4.4 - 5.3)
	B1, B2	14	14	6.5	M3 	0.5 - 0.6 (4.4 - 5.3)
		14	14	-	M3.5 	0.8 - 1.0 (7.1 - 8.9)



















Model	Terminal	Recomm. Gauge AWG, kcmil	Applicable Gauge AWG, kcmil	Wire Stripping Length mm	Terminal Screw Size and Shape	Tightening Torque N-m (lbf-in)
2006	R/L1, S/L2, T/L3	14	14	6.5	M3 ⊖	0.5 - 0.6 (4.4 - 5.3)
	U/T1, V/T2, W/T3	14	14	6.5	M3 ⊖	0.5 - 0.6 (4.4 - 5.3)
	-, +1, +2	14	14	6.5	M3 ⊖	0.5 - 0.6 (4.4 - 5.3)
	B1, B2	14	14	6.5	M3 ⊖	0.5 - 0.6 (4.4 - 5.3)
	⊕	14	14	-	M3.5 ⊕	0.8 - 1.0 (7.1 - 8.9)
2010	R/L1, S/L2, T/L3	14	14 - 12	8	M3 ⊖	0.5 - 0.6 (4.4 - 5.3)
	U/T1, V/T2, W/T3	14	14 - 12	8	M3 ⊖	0.5 - 0.6 (4.4 - 5.3)
	-, +1, +2	12	14 - 10	8	M3 ⊖	0.5 - 0.6 (4.4 - 5.3)
	B1, B2	14	14 - 12	8	M3 ⊖	0.5 - 0.6 (4.4 - 5.3)
	⊕	10	14 - 10	-	M4 ⊕	1.2 - 1.5 (10.6 - 13.3)
2012	R/L1, S/L2, T/L3	12	14 - 10	8	M3 ⊖	0.5 - 0.6 (4.4 - 5.3)
	U/T1, V/T2, W/T3	12	14 - 10	8	M3 ⊖	0.5 - 0.6 (4.4 - 5.3)
	-, +1, +2	10	12 - 10	8	M3 ⊖	0.5 - 0.6 (4.4 - 5.3)
	B1, B2	14	14 - 12	8	M3 ⊖	0.5 - 0.6 (4.4 - 5.3)
	⊕	10	14 - 10	-	M4 ⊕	1.2 - 1.5 (10.6 - 13.3)



















Model	Terminal	Recomm. Gauge AWG, kcmil	Applicable Gauge AWG, kcmil	Wire Stripping Length mm	Terminal Screw Size and Shape	Tightening Torque N·m (lbf·in)
2021	R/L1, S/L2, T/L3	8	14 - 8	10	M4 ⊖	1.5 - 1.7 (13.5 - 15)
	U/T1, V/T2, W/T3	10	14 - 8	10	M4 ⊖	1.5 - 1.7 (13.5 - 15)
	-, +1, +2	8	14 - 8	10	M4 ⊖	1.5 - 1.7 (13.5 - 15)
	B1, B2	14	14 - 10	10	M4 ⊖	1.5 - 1.7 (13.5 - 15)
	⊕	8	14 - 8	-	M4 ⊕	1.2 - 1.5 (10.6 - 13.3)
2030	R/L1, S/L2, T/L3	8	12 - 6	10	M4 ⊖	1.5 - 1.7 (13.5 - 15)
	U/T1, V/T2, W/T3	8	12 - 6	10	M4 ⊖	1.5 - 1.7 (13.5 - 15)
	-, +1, +2	6	12 - 6	10	M4 ⊖	1.5 - 1.7 (13.5 - 15)
	B1, B2	12	12 - 8	10	M4 ⊖	1.5 - 1.7 (13.5 - 15)
	⊕	8	10 - 6	-	M5 ⊕	2.0 - 2.5 (17.7 - 22.1)
2042	R/L1, S/L2, T/L3	6	12 - 6	10	M4 ⊖	1.5 - 1.7 (13.5 - 15)
	U/T1, V/T2, W/T3	6	12 - 6	10	M4 ⊖	1.5 - 1.7 (13.5 - 15)
	-, +1, +2	4	10 - 2	18	M5 ⊖	<ul style="list-style-type: none"> • ≤ AWG 10 2.3 - 2.5 (19.8 - 22) • AWG 8 ≤ 4.1 - 4.5 (36 - 40)
	B1, B2	10	14 - 6	10	M4 ⊖	1.5 - 1.7 (13.5 - 15)
	⊕	6	10 - 6	-	M5 ⊕	2.0 - 2.5 (17.7 - 22.1)

Model	Terminal	Recomm. Gauge AWG, kcmil	Applicable Gauge AWG, kcmil	Wire Stripping Length mm	Terminal Screw Size and Shape	Tightening Torque N-m (lbf-in)
2056	R/L1, S/L2, T/L3	4	10 - 2	18	M5 	4.1 - 4.5 (36 - 40)
	U/T1, V/T2, W/T3	4	10 - 2	18	M5 	<ul style="list-style-type: none"> • ≤ AWG 10 2.3 - 2.5 (19.8 - 22) • AWG 8 ≤ 4.1 - 4.5 (36 - 40)
	-, +1, +2	2	8 - 2	18	M5 	4.1 - 4.5 (36 - 40)
	B1, B2	8	12 - 6	10	M4 	1.5 - 1.7 (13.5 - 15)
		6	8 - 4	-	M6 	5.4 - 6.0 (47.8 - 53.1)
2070	R/L1, S/L2, T/L3	2	6 - 1	20	M6 	5 - 5.5 (45 - 49)
	U/T1, V/T2, W/T3	2	8 - 1	20	M6 	5 - 5.5 (45 - 49)
	-, +1, +2	1	6 - 1/0	20	M6 	5 - 5.5 (45 - 49)
	B1, B2	8	12 - 6	10	M4 	1.5 - 1.7 (13.5 - 15)
		4	6 - 4	-	M6 	5.4 - 6.0 (47.8 - 53.1)













*1 Remove insulation from the ends of wires to expose the length of wire shown.

■ Three-Phase 400 V Class

Model	Terminal	Recomm. Gauge AWG, kcmil	Applicable Gauge AWG, kcmil	Wire Stripping Length mm	Terminal Screw Size and Shape	Tightening Torque N·m (lbf·in)
4001	R/L1, S/L2, T/L3	14	14 - 12	8	M3 	0.5 - 0.6 (4.4 - 5.3)
	U/T1, V/T2, W/T3	14	14 - 12	8	M3 	0.5 - 0.6 (4.4 - 5.3)
	-, +1, +2	14	14 - 12	8	M3 	0.5 - 0.6 (4.4 - 5.3)
	B1, B2	14	14 - 12	8	M3 	0.5 - 0.6 (4.4 - 5.3)
		14	14 - 10	-	M4 	1.2 - 1.5 (10.6 - 13.3)
4002	R/L1, S/L2, T/L3	14	14 - 12	8	M3 	0.5 - 0.6 (4.4 - 5.3)
	U/T1, V/T2, W/T3	14	14 - 12	8	M3 	0.5 - 0.6 (4.4 - 5.3)
	-, +1, +2	14	14 - 12	8	M3 	0.5 - 0.6 (4.4 - 5.3)
	B1, B2	14	14 - 12	8	M3 	0.5 - 0.6 (4.4 - 5.3)
		14	14 - 10	-	M4 	1.2 - 1.5 (10.6 - 13.3)
4004	R/L1, S/L2, T/L3	14	14 - 12	8	M3 	0.5 - 0.6 (4.4 - 5.3)
	U/T1, V/T2, W/T3	14	14 - 12	8	M3 	0.5 - 0.6 (4.4 - 5.3)
	-, +1, +2	14	14 - 12	8	M3 	0.5 - 0.6 (4.4 - 5.3)
	B1, B2	14	14 - 12	8	M3 	0.5 - 0.6 (4.4 - 5.3)
		10	14 - 10	-	M4 	1.2 - 1.5 (10.6 - 13.3)

Model	Terminal	Recomm. Gauge AWG, kcmil	Applicable Gauge AWG, kcmil	Wire Stripping Length mm	Terminal Screw Size and Shape	Tightening Torque N-m (lbf-in)
4005	R/L1, S/L2, T/L3	14	14 - 12	8	M3 	0.5 - 0.6 (4.4 - 5.3)
	U/T1, V/T2, W/T3	14	14 - 12	8	M3 	0.5 - 0.6 (4.4 - 5.3)
	-, +1, +2	14	14 - 12	8	M3 	0.5 - 0.6 (4.4 - 5.3)
	B1, B2	14	14 - 12	8	M3 	0.5 - 0.6 (4.4 - 5.3)
		10	14 - 10	-	M4 	1.2 - 1.5 (10.6 - 13.3)
4007	R/L1, S/L2, T/L3	14	14 - 12	8	M3 	0.5 - 0.6 (4.4 - 5.3)
	U/T1, V/T2, W/T3	14	14 - 12	8	M3 	0.5 - 0.6 (4.4 - 5.3)
	-, +1, +2	14	14 - 12	8	M3 	0.5 - 0.6 (4.4 - 5.3)
	B1, B2	14	14 - 12	8	M3 	0.5 - 0.6 (4.4 - 5.3)
		10	14 - 10	-	M4 	1.2 - 1.5 (10.6 - 13.3)
4009	R/L1, S/L2, T/L3	14	14 - 12	8	M3 	0.5 - 0.6 (4.4 - 5.3)
	U/T1, V/T2, W/T3	14	14 - 12	8	M3 	0.5 - 0.6 (4.4 - 5.3)
	-, +1, +2	14	14 - 12	8	M3 	0.5 - 0.6 (4.4 - 5.3)
	B1, B2	14	14 - 12	8	M3 	0.5 - 0.6 (4.4 - 5.3)
		10	14 - 10	-	M4 	1.2 - 1.5 (10.6 - 13.3)

Model	Terminal	Recomm. Gauge AWG, kcmil	Applicable Gauge AWG, kcmil	Wire Stripping Length mm	Terminal Screw Size and Shape	Tightening Torque N·m (lbf·in)
4012	R/L1, S/L2, T/L3	12	14 - 10	10	M4 ⊖	1.5 - 1.7 (13.5 - 15)
	U/T1, V/T2, W/T3	14	14 - 12	10	M4 ⊖	1.5 - 1.7 (13.5 - 15)
	-, +1, +2	10	12 - 8	10	M4 ⊖	1.5 - 1.7 (13.5 - 15)
	B1, B2	14	14 - 12	10	M4 ⊖	1.5 - 1.7 (13.5 - 15)
	⊕	10	14 - 10	-	M4 ⊕	1.2 - 1.5 (10.6 - 13.3)
4018	R/L1, S/L2, T/L3	10	12 - 8	10	M4 ⊖	1.5 - 1.7 (13.5 - 15)
	U/T1, V/T2, W/T3	10	12 - 8	10	M4 ⊖	1.5 - 1.7 (13.5 - 15)
	-, +1, +2	10	14 - 8	10	M4 ⊖	1.5 - 1.7 (13.5 - 15)
	B1, B2	14	14 - 12	10	M4 ⊖	1.5 - 1.7 (13.5 - 15)
	⊕	10	14 - 6	-	M5 ⊕	2.0 - 2.5 (17.7 - 22.1)
4023	R/L1, S/L2, T/L3	8	14 - 6	10	M4 ⊖	1.5 - 1.7 (13.5 - 15)
	U/T1, V/T2, W/T3	10	14 - 8	10	M4 ⊖	1.5 - 1.7 (13.5 - 15)
	-, +1, +2	8	12 - 6	10	M4 ⊖	1.5 - 1.7 (13.5 - 15)
	B1, B2	12	14 - 10	10	M4 ⊖	1.5 - 1.7 (13.5 - 15)
	⊕	10	10 - 6	-	M5 ⊕	2.0 - 2.5 (17.7 - 22.1)

Model	Terminal	Recomm. Gauge AWG, kcmil	Applicable Gauge AWG, kcmil	Wire Stripping Length mm	Terminal Screw Size and Shape	Tightening Torque N-m (lbf-in)
4031	R/L1, S/L2, T/L3	8	12 - 6	10	M4 	1.5 - 1.7 (13.5 - 15)
	U/T1, V/T2, W/T3	8	12 - 6	10	M4 	1.5 - 1.7 (13.5 - 15)
	-, +1, +2	6	12 - 4	18	M5 	<ul style="list-style-type: none"> • ≤ AWG 10 2.3 - 2.5 (19.8 - 22) • AWG 8 ≤ 4.1 - 4.5 (36 - 40)
	B1, B2	10	12 - 8	10	M4 	1.5 - 1.7 (13.5 - 15)
		8	10 - 6	-	M6 	5.4 - 6.0 (47.8 - 53.1)
4038	R/L1, S/L2, T/L3	6	12 - 6	10	M4 	1.5 - 1.7 (13.5 - 15)
	U/T1, V/T2, W/T3	8	12 - 6	10	M4 	1.5 - 1.7 (13.5 - 15)
	-, +1, +2	4	10 - 2	18	M5 	<ul style="list-style-type: none"> • ≤ AWG 10 2.3 - 2.5 (19.8 - 22) • AWG 8 ≤ 4.1 - 4.5 (36 - 40)
	B1, B2	10	14 - 6	10	M4 	1.5 - 1.7 (13.5 - 15)
		6	10 - 6	-	M6 	5.4 - 6.0 (47.8 - 53.1)

*1 Remove insulation from the ends of wires to expose the length of wire shown.

◆ Motor and Main Circuit Connections

⚠ WARNING *Electrical Shock Hazard. Do not connect terminals R/L1, S/L2, T/L3, L/L1, N/L2, U/T1, V/T2, W/T3, -, +1, +2, B1, or B2 to the ground terminal. If you connect these terminals to earth ground, it can cause damage to the drive or serious injury or death.*

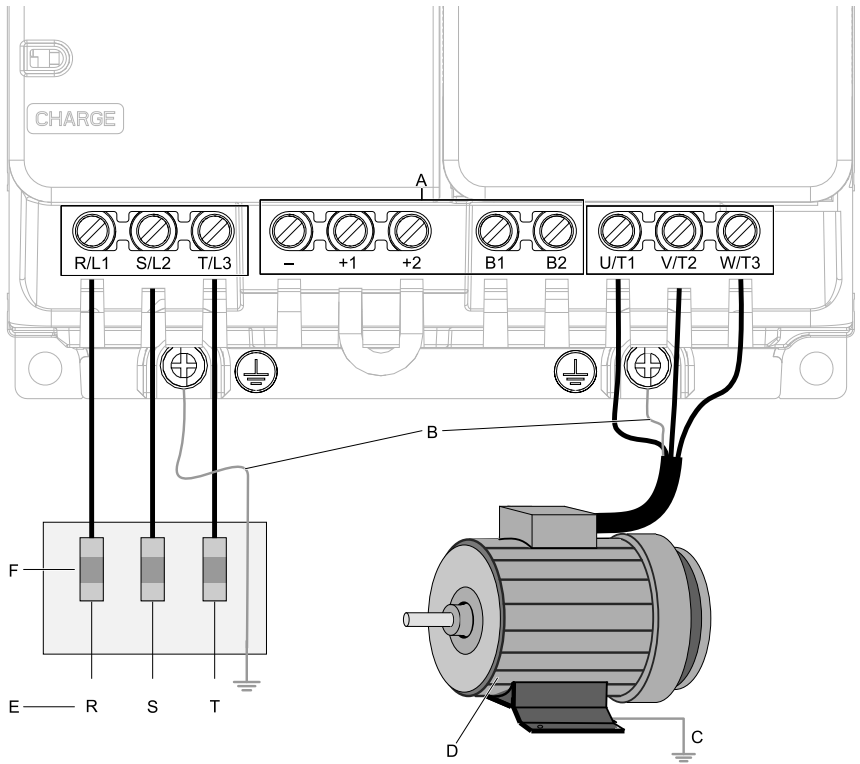
**Note:**

The locations of terminals are different for different drive models.

- A** - DC bus terminal
- B** - Connect to the drive ground terminal.
- C** - Ground the motor case.
- D** - Three-Phase Motor
- E** - Use terminals R/L1, S/L2, and T/L3 for three-phase power supply input. Use terminals L/L1 and N/L2 for single-phase power supply input.
- F** - Input Protection (Fuses or Circuit Breakers)

Figure 10.10 Wiring the Main Circuit and Motor

◆ Control Circuit Terminal Block Functions

Hx-xx parameters set functions for the multi-function input and output terminals.

⚠ WARNING *Sudden Movement Hazard. Correctly wire and test all control circuits to make sure that the control circuits operate correctly. If you use a drive that has incorrect control circuit wiring or operation, it can cause death or serious injury.*

⚠ WARNING *Sudden Movement Hazard. Check the I/O signals and the external sequences for the drive before you set the Application Preset function. When you set the Application Preset function (A1-06 ≠ 0), it changes the I/O terminal functions for the drive and it can cause equipment to operate unusually. This can cause serious injury or death.*

NOTICE *Damage to Equipment. Do not energize and de-energize the drive more frequently than one time each 30 minutes. If you frequently energize and de-energize the drive, it can cause drive failure.*

■ Input Terminals

Refer to [Table 10.4](#) for a list of input terminals and functions.

Table 10.4 Multi-function Input Terminals

Type	Terminal	Name (Default)	Function (Signal Level)
MFDI	S1	MFDI selection 1 (ON: Forward run, OFF: Stop)	<ul style="list-style-type: none"> Photocoupler 24 V, 6 mA <p>Note: To set the MFDI power supply (Sinking/ Sourcing Mode or internal/external power supply), install or remove a jumper between terminals SC-SP or SC-SN depending on the application.</p> <ul style="list-style-type: none"> Sinking Mode, Internal power supply: Install the jumper to close the circuit between terminals SC-SP. <p>NOTICE <i>Damage to Equipment. Do not close the circuit between terminals SC-SN. If you close the circuits between terminals SC-SP and terminals SC-SN at the same time, it will cause damage to the drive.</i></p>
	S2	MFDI selection 2 (ON: Reverse run, OFF: Stop)	
	S3	MFDI selection 3 (External fault (N.O.))	
	S4	MFDI selection 4 (Fault reset)	
	S5	MFDI selection 5 (Multi-step speed reference 1)	
	S6	MFDI selection 6 (Multi-step speed reference 2)	
	S7	MFDI selection 7 (Jog command)	
	SN	MFDI power supply 0 V	MFDI power supply, 24 V (maximum 150 mA)
	SC	MFDI selection common	
	SP	MFDI power supply +24 Vdc	

Type	Terminal	Name (Default)	Function (Signal Level)
Safe disable input	H1	Safe Disable input 1	Remove the jumper between terminals H1-HC and H2-HC to use the Safe Disable input. <ul style="list-style-type: none"> • 24 V, 6 mA • ON: Normal operation • OFF: Coasting motor • Internal impedance 4.7 kΩ • Minimum OFF time of 3 ms.
	H2	Safe Disable input 2	
	HC	Safe Disable function common	Safe Disable function common NOTICE Do not close the circuit between terminals HC and SN. A closed circuit between these terminals will cause damage to the drive.
Master Frequency Reference	RP	Master frequency reference pulse train input (Master frequency reference)	<ul style="list-style-type: none"> • Response frequency: 0 kHz to 32 kHz • H level duty: 30% to 70% • H level voltage: 3.5 V to 13.2 V • L level voltage: 0.0 V to 0.8 V • Input impedance: 3 kΩ
	+V	Power supply for frequency setting	10.5 V (allowable current 20 mA maximum)
	A1	MFAI1 (Master frequency reference)	Voltage input Use H3-01 [Terminal A1 Signal Level Select] to select the signal level. <ul style="list-style-type: none"> • 0 V to 10 V/ 100% (input impedance: minimum 15 kΩ) • -10 V to +10 V/-100% to +100% (input impedance: minimum 15 kΩ)
	A2	MFAI2 (Combined to terminal A1)	Voltage input or current input Use DIP switch S1 and H3-09 [Terminal A2 Signal Level Select] to select the input. <ul style="list-style-type: none"> • 0 V to 10 V/ 100% (input impedance: minimum 15 kΩ) • -10 V to +10 V/-100% to +100% (input impedance: minimum 15 kΩ) • 4 mA to 20 mA/100%, 0 mA to 20 mA/ 100% (input impedance: 250 Ω)
	AC	Frequency reference common	0 V

■ Output Terminals

Refer to [Table 10.5](#) and [Table 10.6](#) for a list of Output terminals and functions.

Table 10.5 Control Circuit Output Terminals

Type	Terminal	Name (Default)	Function (Signal Level)
Digital Outputs	MA	N.O. output (Fault)	<ul style="list-style-type: none"> Relay output 30 Vdc, 10 mA to 1 A 250 Vac, 10 mA to 1 A Minimum load: 5 V, 10 mA (Reference value)
	MB	N.C. output (Fault)	
	MC	Digital output common	
Multi-function Photocoupler Outputs	P1	Multi-function photocoupler output 1 (During RUN)	<ul style="list-style-type: none"> Photocoupler output 48 V, 2 mA to 50 mA
	C1		
	P2	Multi-function photocoupler output 2 (Speed agree 1)	
	C2		

Table 10.6 Control Circuit Monitor Output Terminals

Type	Terminal	Name (Default)	Function (Signal Level)
Monitor Output	MP	Pulse train output (Output frequency)	32 kHz (maximum) Refer to "Pulse Train Output" (page 85) for more information.
	AM	Analog monitor output (Output frequency)	Select voltage or current output. <ul style="list-style-type: none"> 0 V to 10 V/0% to 100% 4 mA to 20 mA (Receiver recommended impedance: 250 Ω) <p>Note: Use jumper S5 and H4-07 [<i>Terminal AM Signal Level Select</i>] to set the signal type.</p>
	AC	Monitor common	0 V

■ External Power Supply Input Terminals

Refer to [Table 10.7](#) for a list of the functions of the external power supply input terminals.

Table 10.7 External Power Supply Input Terminals

Type	Terminal	Name (Default)	Function
External Power Supply Input Terminals	PS	External 24 V power supply input	Supplies backup power to the drive control circuit, keypad, and option board. 21.6 VDC to 26.4 VDC, 700 mA
	AC	External 24 V power supply ground	0 V

■ Serial Communication Terminals

Refer to [Table 10.8](#) for a list of serial communication terminals and functions.

Table 10.8 Serial Communication Terminals

Type	Terminal	Terminal Name	Function (Signal Level)	
Modbus Communication	D+	Communication input/output (+)	MEMOBUS/Modbus communications Use an RS-485 cable to connect the drive.	<ul style="list-style-type: none"> • RS-485 • MEMOBUS/Modbus communication protocol • Maximum 115.2 kbps
	D-	Communication output (-)	Note: Set DIP switch S2 to ON to enable the termination resistor in the last drive in a MEMOBUS/Modbus network.	
	AC	Shield ground	0 V	

◆ Control Circuit Terminal Configuration

The control circuit terminals are in the positions shown in [Figure 10.11](#).

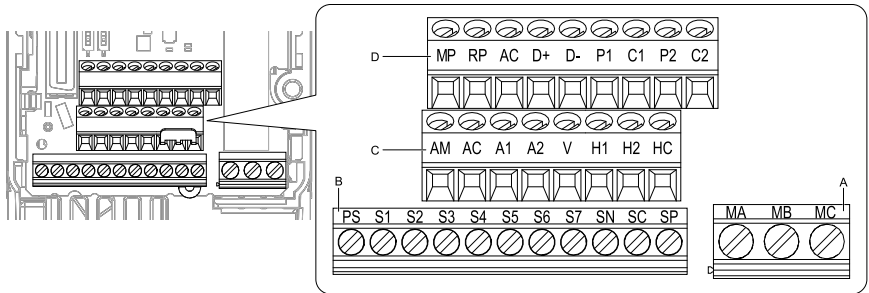

A - Terminal block (TB2)

C - Terminal block (TB1-2)

B - Terminal block (TB1-1)

D - Terminal block (TB1-3)

Figure 10.11 Control Circuit Terminal Arrangement

■ Control Circuit Wire Gauges and Tightening Torques

Use the tables in this section to select the correct wires. Use shielded wire to wire the control circuit terminal block. Use crimp ferrules on the wire ends to make the wiring procedure easier and more reliable.

Table 10.9 Control Circuit Wire Gauges and Tightening Torques

Terminal Block	Terminal	Screw Size	Tightening Torque N-m (lbf-in)	Bare Wire		Crimp Ferrule	
				Recomm. Gauge mm ² (AWG)	Applicable Gauge mm ² (AWG)	Recomm. Gauge mm ² (AWG)	Applicable Gauge mm ² (AWG)
TB1-1	PS, S1 - S7, SN, SC, SP	M2	0.22 - 0.25 (1.95 - 2.21)	0.75 (18)	<ul style="list-style-type: none"> Stranded wire 0.25 - 1.0 (24 - 17) Solid wire 0.25 - 1.5 (24 - 16) 	0.5 (20)	0.25 - 0.5 (24 - 20)
TB1-2	AM, AC, A1, A2, +V, H1, H2, HC						
TB1-3	MP, RP, AC, D+, D-, P1, C1, P2, C2						
TB2	MA, MB, MC	M3	0.5 - 0.6 (4.4 - 5.3)	0.75 (18)	<ul style="list-style-type: none"> Stranded wire 0.25 - 1.5 (24 - 16) Solid wire 0.25 - 1.5 (24 - 16) 	0.5 (20)	0.25 - 1.0 (24 - 17)

Crimp Ferrules

Attach an insulated sleeve when you use crimp ferrules. Refer to [Table 10.10](#) for the recommended external dimensions and model numbers of crimp ferrules.

Use the CRIMPFOX 6, a crimping tool made by PHOENIX CONTACT.

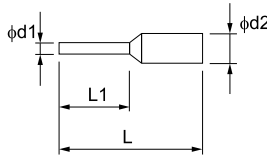

Figure 10.12 External Dimensions of Crimp Ferrules

Table 10.10 Crimp Ferrule Models and Sizes

Wire Gauge mm ² (AWG)	Model	L (mm)	L1 (mm)	φd1 (mm)	φd2 (mm)
0.25 (24)	AI 0.25-6 YE AI 0.25-6 BU	10.5	6.0	0.8	2.0
0.34 (22)	AI 0.34-6 TQ	10.5	6.0	0.8	2.0
0.5 (20)	AI 0.5-6 WH AI 0.5-6 OG	12.0	6.0	1.1	2.5
0.75 (18)	AI 0.75-6 GY AI 0.75-6 WH	12.0	6.0	1.3	2.8
1.0 (17)	AI 1-6 RD AI 1-6 YE	12.0	6.0	1.5	3.0

◆ Wiring the Control Circuit Terminal

⚠ WARNING *Electrical Shock Hazard. Do not remove covers or touch circuit boards while the drive is energized. If you touch the internal components of an energized drive, it can cause serious injury or death.*

NOTICE *Do not let wire shields touch other signal lines or equipment. Insulate the wire shields with electrical tape or shrink tubing. If you do not insulate the wire shields, it can cause a short circuit and damage the drive.*

Note:

- Use a Class 2 power supply to connect external power to the control terminals. If the power supply for peripheral devices is incorrect, it can cause a decrease in drive performance.
- Connect the shield of shielded cable to the applicable ground terminal. Incorrect equipment grounding can cause drive or equipment malfunction from electrical interference.
- Isolate wiring for contact output terminals MA, MB, MC, P1, C1, P2, and C2 from other control circuit wiring. Incorrect wiring procedures can cause the drive and connected equipment to malfunction and cause the drive to trip.
- Isolate control circuit wiring from main circuit wiring (terminals R/L1, S/L2, T/L3, L/L1, N/L2, B1, B2, U/ T1, V/T2, W/T3, -, +1, +2) and other high-power wiring. If control circuit wiring is adjacent to main circuit wiring, it can cause incorrect operation of the drive and equipment from electrical interference.

Wire the grounding terminal and main circuit terminals, then wire the control circuit terminals.

1. Remove the front cover from the drive.
You must remove the keypad to move Jumper S5.

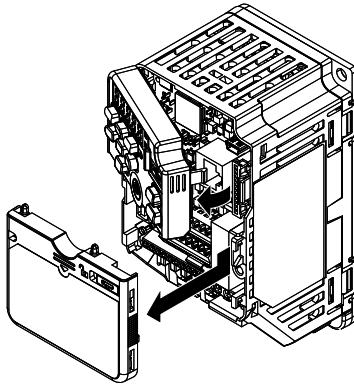

Figure 10.13 Remove the Front Cover

2. Refer to the figure and wire the control circuit.
Use a slotted screwdriver with a blade width of 2.5 mm (0.1 in) or less and thickness of 0.4 mm (0.01 in) or less.

⚠ WARNING *Fire Hazard. Tighten all terminal screws to the correct tightening torque. Connections that are too loose or too tight can cause incorrect operation and damage to the drive. Incorrect connections can also cause death or serious injury from fire.*

Note:

- Use shielded, twisted-pair wires and ground the shield to the ground terminal of the drive. Incorrect equipment grounding can cause drive or equipment malfunction from electrical interference.
- Do not use control circuit wiring that is longer than 50 m (164 ft) to supply the analog frequency reference from a remote source. If the control circuit wiring is too long, it can cause unsatisfactory system performance.

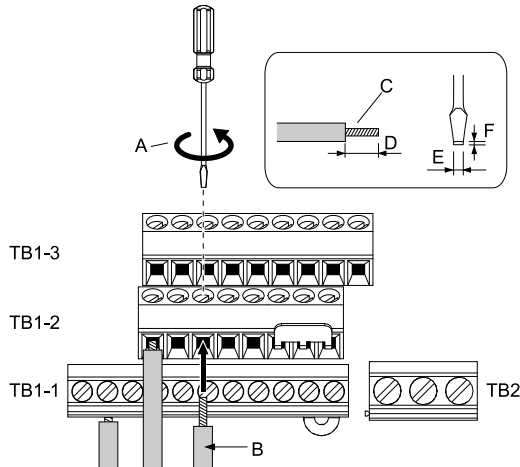

- A - Loosen the screws and put the wire into the opening on the terminal block.**
- B - Wire with a crimp ferrule attached, or unsoldered wire with the core wires lightly twisted**
- C - Pull back the shielding and lightly twist the end with your fingers to keep the ends from fraying.**
- D - When you do not use crimp ferrules, remove approximately 5.5 mm (0.21 in) of the covering at the end of the wire.**
- E - Blade width of 2.5 mm (0.1 in) or less**
- F - Blade thickness of 0.4 mm (0.01 in) or less**

Figure 10.14 Wiring Procedure for the Control Circuit

Note:

- It is easier to wire TB1-1 first, then TB1-2, then TB1-3.
- Do not solder the core wire. Soldered wiring connections can become loose and cause the drive to malfunction.
- Tighten all terminal screws to the correct tightening torque. Connections that are too loose or too tight can cause incorrect operation and damage to the drive. Incorrect connections can also cause death or serious injury from fire.
- Refer to [Figure 10.15](#) for information to prepare terminal ends of the shielded wire.
- Prepare the wire ends of shielded twisted-pair wires as shown in [Figure 10.15](#) to use an analog reference from an external frequency setting potentiometer to set the frequency. Connect the shield to the ground terminal (⊕) of the drive.

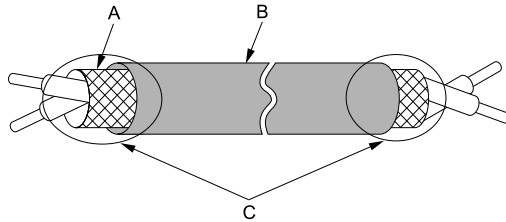

- A - Connect the shield to the ground terminal of the drive.** **C - Insulate with electrical tape or shrink tubing.**
B - Sheath

Figure 10.15 Prepare the Ends of Shielded Wire

3. Attach the front cover.

If you moved Jumper S5, attach the keypad before you attach the front cover.

If you did not move Jumper S5, attach the front cover.

Make sure that you do not pinch wires or signal lines between the front cover and the drive before you reattach the cover.

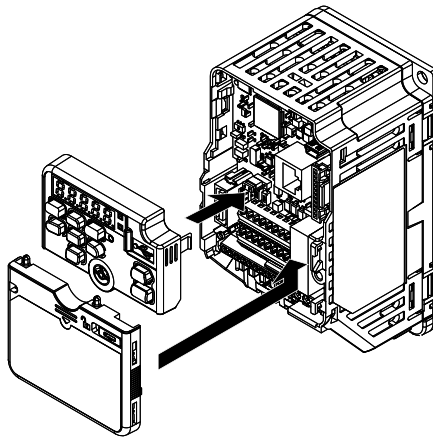

Figure 10.16 Reattach the Front Cover

◆ Switches and Jumpers on the Terminal Board

The terminal board has switches to adapt the drive I/Os to the external control signals as shown in [Figure 10.17](#).

Set the switches to select the functions for each terminal.

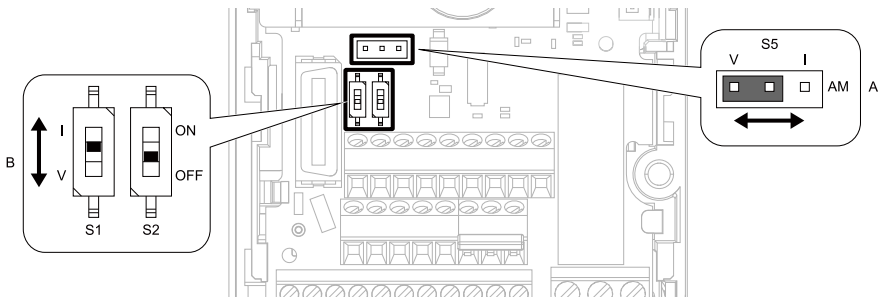

Figure 10.17 Locations of Switches

Table 10.11 I/O Terminals and Switches Functions

Position	Switch	Terminal	Function	Default
A	Jumper switch S5	AM	Sets the output method for terminal AM (voltage or current).	V (voltage output)
B	DIP switch S1	A2	Sets the input method for terminal A2 (voltage or current).	I (current input)
	DIP switch S2	-	Enables and disables the MEMOBUS/Modbus communications termination resistor.	OFF

◆ **Control I/O Connections**

This section gives information about the settings for the listed control circuit I/O signals.

- MFDI (terminals S1 to S7)
- Pulse train output (terminal MP)
- MFAI (terminal A2)
- MFAO (terminal AM)
- MEMOBUS/Modbus communications (terminals D+, D-, AC)

■ **Set Sinking Mode/Sourcing Mode**

Close the circuit between terminals SC-SP and SC-SN to set the sinking mode/sourcing mode and the internal/external power supply for the MFDI terminals. The default setting for the drive is internal power supply sinking mode.

NOTICE *Damage to Equipment. Do not close the circuit between terminals SP-SN. If you close the circuits between terminals SC-SP and terminals SC-SN at the same time, it will cause damage to the drive.*

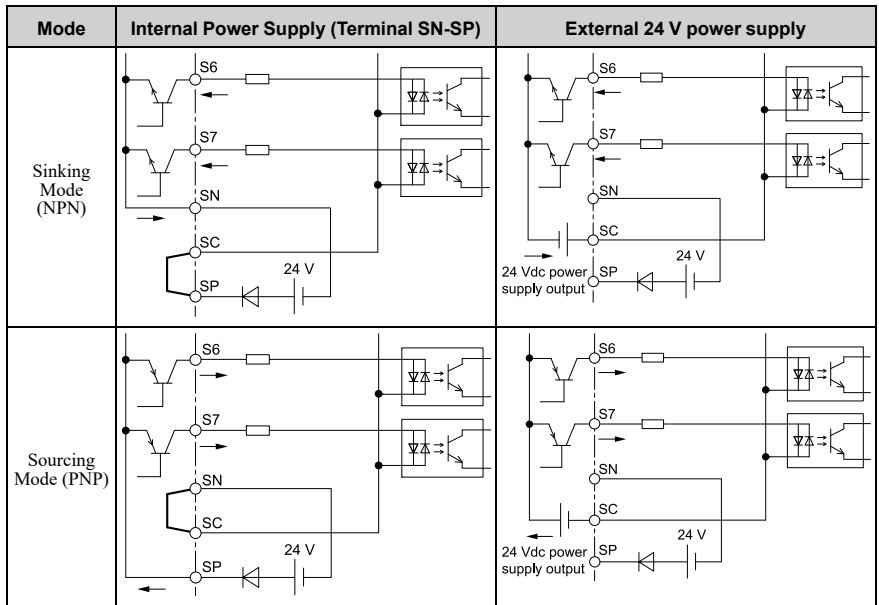

■ Pulse Train Output

You can use pulse train monitor output terminal MP for sourcing mode or for sinking mode.

- Use for sourcing mode
The load impedance changes the voltage level of the pulse train output signal.

Load Impedance $R_L(k\Omega)$	Output Voltage $V_{MP}(V)$
1.5 k Ω or more	5 V or more
4.0 k Ω or more	8 V or more
10 k Ω or more	10 V or more

Note:

Use the formula in [Figure 10.18](#) to calculate the necessary load resistance (k Ω) to increase output voltage V_{MP} (V).

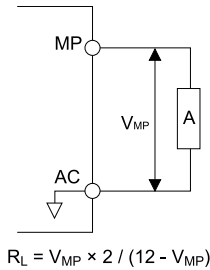

A - Load Impedance

Figure 10.18 Wiring to Use Pulse Train Output in Sourcing Mode

- Use in sinking mode
The external power supply changes the voltage level of the pulse train output signal. Keep the voltage from an external source between 10.8 Vdc to 16.5 Vdc. Adjust the load impedance to keep the current at 16 mA or lower.

External Power Supply (V)	Load Impedance (kΩ)	Sinking current (mA)
10.8 Vdc to 16.5 Vdc	1.0 kΩ or more	16 mA maximum

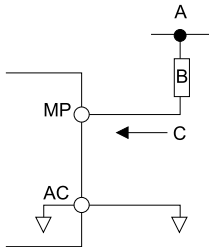

A - External power supply

C - Sinking current

B - Load Impedance

Figure 10.19 Wiring to Use Pulse Train Output in Sinking Mode

■ Set the Input Signal for the MFAI Terminal A2

Use terminal A2 to input a voltage or a current signal. Set the signal type as shown in Table 10.12.

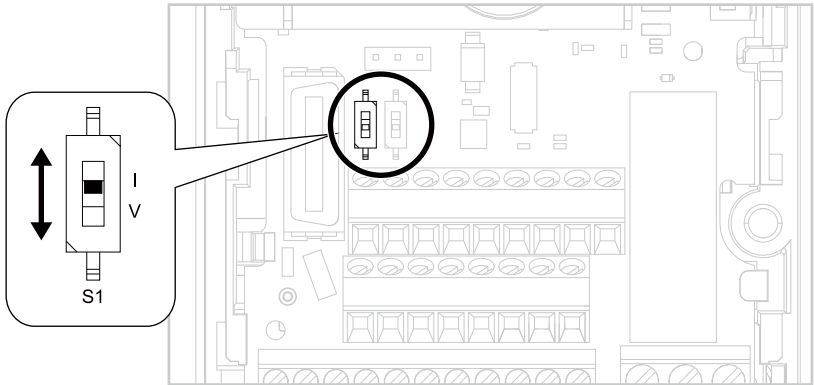

Figure 10.20 Location of DIP Switch S1

Table 10.12 MFAI Terminal A2 Signal Settings

Terminal	Input Signal	DIP Switch Settings		Parameter	
		Switch	Setting	No.	Signal Level
A2	Current input	S1	I (Default)	H3-09	2: 4 mA to 20 mA/0% to 100% (input impedance: 250 Ω) 3: 0 mA to 20 mA/0% to 100% (input impedance: 250 Ω)
	Voltage input		V		0: 0 V to 10 V/0% to 100% (with zero limit) (input impedance: minimum 15 kΩ) 4: -10 V to +10 V/-100% to 100% (input impedance: minimum 15 kΩ)

Note:

Use tweezers or a jig with a tip width of approximately 0.8 mm (0.03 in) to set DIP switches.

■ **Set the Output Signal for the MFAO Terminal AM**

Set the signal type for terminal AM to voltage or current output. Use jumper S5 and H4-07 [Terminal AM Signal Level Select] to set the signal type.

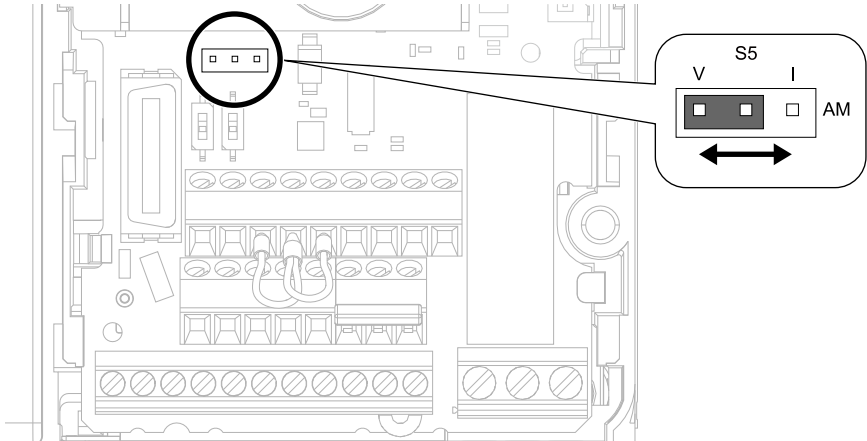
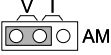
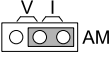

Figure 10.21 Location of Jumper Switch S5

Terminal	Types of Output Signals	Jumper S5	Parameter	
			No.	Signal Level
AM	Voltage output (Default)	 AM	H4-07	0: 0 V to 10 V
	Current output	 AM		2: 4 mA to 20 mA

■ Switch ON Termination Resistor for MEMOBUS/Modbus Communications

When the drive is the last slave in a MEMOBUS/Modbus communications, set DIP switch S2 to the ON position. This drive has a built-in termination resistor for the RS-485 interface.

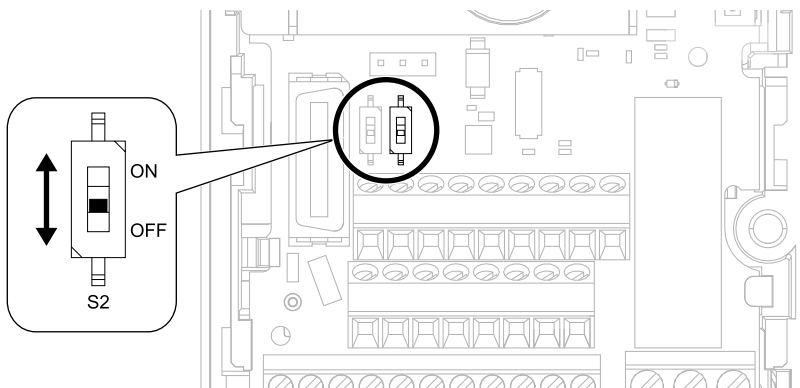

Figure 10.22 Location of DIP Switch S2

Table 10.13 MEMOBUS/Modbus Communications Termination Resistor Setting

DIP switch S2	Description
ON	The built-in termination resistor is ON.
OFF (Default)	The built-in termination resistor is OFF.

11 Auto-Tuning

Auto-Tuning uses motor characteristics to automatically set drive parameters for vector control. Think about the type of motor, drive control method, and the motor installation environment and select the best Auto-Tuning method.

▲ WARNING *Injury to Personnel. Rotational Auto-Tuning rotates the motor at 50% or more of the motor rated frequency. Make sure that there are no issues related to safety in the area around the drive and motor. Increased motor frequency can cause serious injury or death.*

◆ Auto-Tuning for Induction Motors

This section gives information about Auto-Tuning for induction motors. Set motor parameters *E1-xx* and *E2-xx* (or, for motor 2, *E3-xx* and *E4-xx*) for Auto-Tuning.

Note:

Do Stationary Auto-Tuning if you cannot do Rotational Auto-Tuning. There can be large differences between the measured results and the motor characteristics when Auto-Tuning is complete. Examine the parameters for the measured motor characteristics after you do Stationary Auto-Tuning.

Table 11.1 Auto-Tuning Mode Selection

Method	Parameter Settings	Application Conditions and Benefits	Applicable Control Method (A1-02 Setting)	
			V/f (0)	OLV (2)
Rotational Auto-Tuning	T1-01 = 0	<ul style="list-style-type: none"> When you can decouple the motor and load the motor can rotate freely while Auto-Tuning. When operating motors that have fixed output characteristics. When it is necessary to use motors that have high-precision control. When you cannot decouple the motor and load, but the motor load is less than 30%. 	x	x
Stationary Auto-Tuning 1	T1-01 = 1	<ul style="list-style-type: none"> When you cannot decouple the motor and load. When the motor load is more than 30%. When the information from the motor test report or motor nameplate is not available. With Stationary Auto-Tuning, the energized drive stays stopped for approximately 1 minute. During this time, the drive automatically measures the necessary motor parameters. When you operate the motor with less than 30% load after Auto-Tuning. Set <i>T1-12 = 1</i> [<i>Test Mode Selection = Yes</i>] to do a test run after Auto-Tuning. 	-	x
Stationary Line-Line Resistance	T1-01 = 2	<ul style="list-style-type: none"> After Auto-Tuning, the wiring distance between the drive and motor changed by 50 m or more. When the wiring distance is 50 m or more in the V/f Control mode. When the motor output and drive capacity are different. 	x	x

■ Input Data for Induction Motor Auto-Tuning

To do Auto-Tuning, input data for the items in [Table 11.2](#) that have an "x". Before you start Auto-Tuning, prepare the motor test report or record the information from the motor nameplate as a reference.

Table 11.2 Input Data for Induction Motor Auto-Tuning

Input Data	Parameter	Unit	Auto-Tuning Mode (T1-01 Setting)		
			Rotational Auto-Tuning (0)	Stationary Auto-Tuning 1 (1)	Stationary Line-Line Resistance (2)
Motor Rated Power	T1-02	kW	x	x	x
Motor Rated Voltage	T1-03	V	x	x	-
Motor Rated Current	T1-04	A	x	x	x
Motor Base Frequency	T1-05	Hz	x	x	-
Number of Motor Poles	T1-06	-	x	x	-
Motor Base Speed	T1-07	min ⁻¹	x	x	-
Motor No-Load Current	T1-09	A	-	x	-
Motor Rated Slip Frequency	T1-10	Hz	-	x *1	-
Motor Iron Loss	T1-11	W	x *2	-	-
Test Mode Selection *3	T1-12	-	-	x *4	-
No-Load Voltage	T1-13	V	x *5	x *5	-

*1 Shows 0 Hz as the default value. If you do not know the Motor Rated Slip Frequency, keep the setting at 0 Hz.

*2 Input this value when $A1-02 = 0$ [Control Method Selection = V/f].

*3 If $T1-12 = 1$ [Test Mode Selection = Yes], when you run the motor in Drive Mode for the first time after Auto-Tuning, the drive will automatically set E2-02 [Motor Rated Slip] and E2-03 [Motor No-Load Current].

*4 Input this value when $T1-10$ [Motor Rated Slip Frequency] = 0 Hz.

*5 Set the same value to No-Load Voltage as $T1-03$ [Motor Rated Voltage] to get the same characteristics using Yaskawa 1000-Series drives or other legacy models.

◆ Auto-Tuning for PM Motors

This section gives information about Auto-Tuning for PM motors. Auto-Tuning sets motor parameters *E1-xx* and *E5-xx*.

Table 11.3 Auto-Tuning for PM Motors

Mode	Parameter Settings	Application Conditions and Benefits	Applicable Control Method (A1-02 Setting)	
			OLV/PM (5)	AOLV/PM (6)
Manual Entry w/ Motor Data Sheet	T2-01 = 0	<ul style="list-style-type: none"> When the information from the motor test report or motor nameplate is available. Rotational/Stationary Auto-Tuning that energizes the motor is not done. Manually input the necessary motor parameters. 	x	x
PM Stationary Auto-Tuning	T2-01 = 1	<ul style="list-style-type: none"> When the information from the motor test report or motor nameplate is not available. <p>Note: With Stationary Auto-Tuning, the energized drive stays stopped for approximately 1 minute. During this time, the drive automatically measures the necessary motor parameters.</p>	x	x
PM Stationary Auto-Tuning for Stator Resistance	T2-01 = 2	<ul style="list-style-type: none"> After Auto-Tuning, the wiring distance between the drive and motor changed by 50 m (164 ft) or more. When the motor output and drive capacity are different. 	x	x

Mode	Parameter Settings	Application Conditions and Benefits	Applicable Control Method (A1-02 Setting)	
			OLV/PM (5)	AOLV/PM (6)
PM Rotational Auto-Tuning	T2-01 = 4	<ul style="list-style-type: none"> When the information from the motor test report or motor nameplate is not available. When you can decouple the motor and load and the motor can rotate freely while Auto-Tuning. The drive will automatically set the values measured during Auto-Tuning to the motor parameters. 	x	x
High Frequency Injection	T2-01 = 5	<ul style="list-style-type: none"> Automatically sets the control parameters that are necessary to set $n8-35 = 1$ [Initial Pole Detection Method = High Frequency Injection] or $n8-57 = 1$ [HFI Overlap Selection = Enabled]. Applicable to IPM motors only. Do Auto-Tuning with the motor connected to the drive. <p>Note: When you set $n8-35 = 1$ or $n8-57 = 1$, do High Frequency Injection Auto-Tuning. Set the data on the motor nameplate to the drive before you do High Frequency Injection Auto-Tuning. In High Frequency Injection Auto-Tuning, the drive energizes the stopped motor and automatically adjusts the parameters.</p>	x	x

■ Input Data for PM Motor Auto-Tuning

To do Auto-Tuning, input data for the items in [Table 11.4](#) and [Table 11.5](#) that have an "x". Before you start Auto-Tuning, prepare the motor test report or record the information from the motor nameplate as a reference.

Table 11.4 Input Data for PM Motor Auto-Tuning

Input Data	Parameter	Unit	Auto-Tuning Mode (T2-01 Setting)					
			PM Motor Parameter Settings (0)			PM Stationary Auto- Tuning (1)		PM Stationary Auto-Tuning for Stator Resistance (2)
Control Method Selection	A1-02	-	5, 6	5	6	5	6	5, 6
PM Motor Code Selection	T2-02	-	Motor code of Yaskawa motor *1	FFFF *2	FFFF *2	-	-	-
PM Motor Type	T2-03	-	-	-	-	x	x	-
PM Motor Rated Power	T2-04	kW	-	x	x	x	x	-
PM Motor Rated Voltage	T2-05	V	-	x	x	x	x	-
PM Motor Rated Current	T2-06	A	-	x	x	x	x	x
PM Motor Base Frequency	T2-07	Hz	-	x	-	x	-	-
Number of PM Motor Poles	T2-08	-	-	x	x	x	x	-
PM Motor Base Speed	T2-09	min ⁻¹	-	-	x	-	x	-
PM Motor Stator Resistance	T2-10	Ω	x	x	x	-	-	-
PM Motor d-Axis Inductance	T2-11	mH	x	x	x	-	-	-
PM Motor q-Axis Inductance	T2-12	mH	x	x	x	-	-	-
Back-EMF Units Selection	T2-13	-	x	x	x	-	-	-
Back-EMF Voltage Constant (Ke)	T2-14	*3	x	x	x	-	-	-
Pull-In Current Level	T2-15	%	-	-	-	x	x	-

*1 Set the motor code for a Yaskawa PM motor.

*2 Set the motor code to FFFF for a PM motor from a different manufacturer.

*3 Changes when the value set in T2-13 changes.

Table 11.5 Input Data for PM Motor Auto-Tuning

Input Data	Parameter	Unit	Auto-Tuning Mode (T2-01 Setting)		
			PM Rotational Auto-Tuning (4)		High Frequency Injection (5)
Control Method Selection	A1-02	-	5	6	5, 6
PM Motor Code Selection	T2-02	-	-	-	-
PM Motor Type	T2-03	-	x	x	-
PM Motor Rated Power	T2-04	kW	x	x	-
PM Motor Rated Voltage	T2-05	V	x	x	-
PM Motor Rated Current	T2-06	A	x	x	-
PM Motor Base Frequency	T2-07	Hz	x	-	-
Number of PM Motor Poles	T2-08	-	x	x	-
PM Motor Base Speed	T2-09	min ⁻¹	-	x	-
Pull-In Current Level	T2-15	%	x	x	-

◆ Auto-Tuning in EZ Open Loop Vector Control Method

This section gives information about the Auto-Tuning mode for EZ Open Loop Vector Control. Auto-Tuning will set the $E9$ -xx parameters.

Table 11.6 EZ Tuning Mode Selection

Mode	Parameter Settings	Application Conditions and Benefits	Applicable Control Method (A1-02 Setting)
Motor Parameter Setting	T4-01 = 0	<ul style="list-style-type: none"> Applicable when driving an induction motor or a PM motor Suitable for derating torque applications, for example fans and pumps. 	EZOLV (8)
Line-to-Line Resistance	T4-01 = 1	<ul style="list-style-type: none"> After Auto-Tuning, the wiring distance between the drive and motor changed by 50 m or more. When the motor output and drive capacity are different. 	EZOLV (8)

■ Auto-Tuning Input Data in EZ Open Loop Vector Control Method

To do Auto-Tuning, input data for the items in [Table 11.7](#) that have an "x". Before you start Auto-Tuning, prepare the motor test report or record the information from the motor nameplate as a reference.

Table 11.7 Auto-Tuning Input Data in EZ Open Loop Vector Control Method

Input Data	Parameter	Unit	Auto-Tuning Mode (T4-01 Setting)	
			Motor Parameter Setting (0)	Line-to-Line Resistance (1)
Motor Type Selection	T4-02	-	x	-
Motor Max Revolutions	T4-03	min ⁻¹	x	-
Motor Rated Revolutions	T4-04	min ⁻¹	x	-
Motor Rated Frequency	T4-05	Hz	x	-
Motor Rated Voltage	T4-06	V	x	-
Motor Rated Current (FLA)	T4-07	A	x	x
PM Motor Rated Power (kW)	T4-08	kW	x	x
Number of Motor Poles	T4-09	-	x	-

◆ ASR and Inertia Tuning

To increase drive responsiveness and prevent hunting, use Auto-Tuning to automatically adjust the control-related parameters.

These types of Auto-Tuning are available for the control system:

- Deceleration Rate Tuning
- KEB Tuning

Note:

If you do Control Tuning, you cannot set $H1-xx = 16$ [Motor 2 Selection]. Do not do Control Tuning for applications that switch between motor 1 and motor 2.

Table 11.8 Control Loop Tuning Selection

Mode	Parameter Settings	Application Conditions and Benefits	Applicable Control Methods (A1-02 Settings)				
			V/f (0)	OLV (2)	OLV/PM (5)	AOLV/PM (6)	EZOLV (8)
Deceleration Rate Tuning	T3-00 = 2	To automatically adjust the deceleration rate to prevent an <i>ov</i> [Overvoltage] fault.	x	x	x	x	x
KEB Tuning	T3-00 = 3	<ul style="list-style-type: none"> • To automatically adjust parameter settings to prevent an <i>ov</i> [Overvoltage] fault with the KEB Ride-Thru function. • When $L3-11 = 1$ [Overvoltage Suppression Select = Enabled]. 	x	x	x	x	x

■ Deceleration Rate Tuning

Deceleration Rate Tuning automatically sets the deceleration rate to prevent an *ov* [Overvoltage] fault during motor deceleration. Set $C1-11$ [Accel/Decel Time Switchover Freq] first to automatically set parameters $C1-02$ [Deceleration Time 1] (high speed range) and $C1-08$ [Deceleration Time 4] (low speed range).

■ KEB Tuning

KEB Tuning automatically sets parameters used for the KEB Ride-Thru function and for the overvoltage suppression function.

Control Tuning automatically sets the parameters in [Table 11.9](#) to the best values.

Table 11.9 Parameters set in Control Tuning

Parameters Automatically Set	Deceleration Rate Tuning	KEB Tuning
C1-02 [Deceleration Time 1]	x	-
C1-08 [Deceleration Time 4]	x ^{*1}	-
C1-09 [Fast Stop Time]	-	x ^{*2}
L2-06 [Kinetic Energy Backup Decel Time]	-	x ^{*3}
L3-25 [Load Inertia Ratio]	-	x

*1 The drive automatically sets C1-08 [Deceleration Time 4] only when C1-11 [Accel/Decel Time Switchover Freq] $\neq 0$.

*2 When L2-29 = 0 [Kinetic Energy Backup Method = Single Drive KEB Ride-Thru 1], the drive will automatically adjust C1-09 [Fast Stop Time] and will not adjust L2-06 [Kinetic Energy Backup Decel Time]. If you must not change the Fast Stop time, do not do KEB Tuning.

*3 When L2-29 = 1, 2, or 3 [Kinetic Energy Backup Method = Single Drive KEB Ride-Thru 2, System KEB Ride-Thru 1, or System KEB Ride-Thru 2], the drive will automatically adjust L2-06 [Kinetic Energy Backup Decel Time].

◆ Precautions before Auto-Tuning

Examine the topics in this section before you start Auto-Tuning.

■ Prepare for Basic Auto-Tuning

- You must input data from the motor nameplate or motor test report to do Auto-Tuning. Make sure that this data is available before you do Auto-Tuning.
- For best performance, make sure that the drive input supply voltage is equal to or more than the motor rated voltage.

Note:

Better performance is possible when you use a motor with a rated voltage that is less than the input supply voltage (by 20 V for 200 V class models or by 40 V for 400 V class models). This is very important when you operate the motor at more than 90% of base speed, where high torque precision is necessary. If the input power supply is equal to the motor rated voltage, the drive output voltage will not be sufficient and performance will decrease.

- Push  on the keypad to cancel Auto-Tuning.
- If a Safe Disable input signal is input to the drive during Auto-Tuning, Auto-Tuning measurements will not complete successfully. If this occurs, cancel the Auto-Tuning, then do it again.
- [Table 11.10](#) shows the status of multi-function input/output terminals during Auto-Tuning.

Table 11.10 Status of Input/Output Terminals during Auto-Tuning

Auto-Tuning Type	Mode		Parameter	Multi-Function Input	Multi-Function Output ^{*1}
Induction Motor Auto-Tuning	Rotational	Rotational Auto-Tuning	T1-01 = 0	Disabled	Functions the same as during usual operation.
	Stationary	Stationary Auto-Tuning 1	T1-01 = 1	Disabled	Keeps the status at the start of Auto-Tuning.
		Line-to-Line Resistance	T1-01 = 2	Disabled	Keeps the status at the start of Auto-Tuning.
PM Motor Auto-Tuning	Rotational	PM Rotational Auto-tuning	T2-01 = 4	Disabled	Functions the same as during usual operation.
	Stationary	PM Motor Parameter Settings	T2-01 = 0	Disabled	Keeps the status at the start of Auto-Tuning.
		PM Stationary Auto-Tuning	T2-01 = 1	Disabled	Keeps the status at the start of Auto-Tuning.
		PM Stationary Auto-Tuning for Stator Resistance	T2-01 = 2	Disabled	Keeps the status at the start of Auto-Tuning.
		High Frequency Injection	T2-01 = 5	Disabled	Keeps the status at the start of Auto-Tuning.
EZ Tuning	Stationary	Motor Parameter Setting	T4-01 = 0	Disabled	Keeps the status at the start of Auto-Tuning.
		Line-to-Line Resistance	T4-01 = 1	Disabled	Keeps the status at the start of Auto-Tuning.
ASR and Inertia Tuning	Rotational	Deceleration Rate Tuning	T3-00 = 2	Disabled	Functions the same as during usual operation.
		KEB Tuning	T3-00 = 3	Disabled	Functions the same as during usual operation.

*1 When you set a terminal to H2-xx = E [MFDO Function Selection = Fault], it will function the same as during usual operation.

⚠ WARNING Crush Hazard. Wire a sequence that will not let a multi-function output terminal open the holding brake during Stationary Auto-Tuning. If the holding brake is open during Stationary Auto-Tuning, it can cause serious injury or death.

⚠ WARNING *Sudden Movement Hazard. Before you do Rotational Auto-Tuning, disconnect the load from the motor. The load can move suddenly and cause serious injury or death.*

⚠ WARNING *Injury to Personnel. Rotational Auto-Tuning rotates the motor at 50% or more of the motor rated frequency. Make sure that there are no issues related to safety in the area around the drive and motor. Increased motor frequency can cause serious injury or death.*

⚠ WARNING *Electrical Shock Hazard. During Auto-Tuning, the motor will receive high voltage when the motor is stopped. Do not touch the motor until Auto-Tuning is complete. If you touch a motor that is energized, it can cause serious injury or death.*

■ Precautions before Rotational Auto-Tuning

⚠ WARNING *Electrical Shock Hazard. During Auto-Tuning, the motor will receive high voltage when the motor is stopped. Do not touch the motor until Auto-Tuning is complete. If you touch a motor that is energized, it can cause serious injury or death.*

- Before you do Rotational Auto-Tuning to prevent drive malfunction, uncouple the motor from the load. If you do Rotational Auto-Tuning with the motor connected to a load that is more than 30% of the motor duty rating, the drive will not correctly calculate the motor parameters and the motor can operate incorrectly.
- When the load is 30% or less of the motor duty rating, you can do Auto-Tuning with the motor connected to a load.
- Make sure that the motor magnetic brake is released.
- Make sure that external force from the machine will not cause the motor to rotate.

■ Precautions before Stationary Auto-Tuning

- Make sure that the motor magnetic brake is not open.
- Make sure that external force from the machine will not cause the motor to rotate.

⚠ WARNING *Electrical Shock Hazard. During Auto-Tuning, the motor will receive high voltage when the motor is stopped. Do not touch the motor until Auto-Tuning is complete. If you touch a motor that is energized, it can cause serious injury or death.*

■ Automatically Set E2-02 [Motor Rated Slip] and E2-03 [Motor No-Load Current]

If $TI-12 = 1$ [Test Mode Selection = Yes] when selecting Stationary Auto-Tuning, the drive will automatically set motor parameters E2-02 [Motor Rated Slip] and E2-03 [Motor No-Load Current] after Auto-Tuning is complete when you use the motor for the first time in Drive Mode.

After Stationary Auto-Tuning is complete, use this procedure to do the operation in test mode:

1. Check the E2-02 and E2-03 values on the “Modified Parameters/Fault Log” screen or the “Parameters” screen.
2. Operate the motor in Drive Mode with these conditions:
 - Make sure that you connect all wiring between the drive and motor

- Make sure that a mechanical brake on the motor shaft is not locked
 - The maximum motor load must be 30% of the rated load.
 - Keep a constant speed of 30% of $E1-06$ [*Base Frequency*] (default value = maximum frequency) or more for 1 second or longer.
3. After the motor stops, examine the values of $E2-02$ and $E2-03$ again in the Verify Menu or Parameter Setting Mode.
 4. Make sure that the input data is correct.
When the settings in $E2-02$ and $E2-03$ are different than in step 1, the drive set the values automatically.

■ Precautions before Stationary Auto-Tuning for Line-to-Line Resistance and Stator Resistance Auto-Tuning

In V/f control, when the motor cable is 50 meters (164 feet) or longer, do Stationary Auto-Tuning for Line-to-Line Resistance.

▲ WARNING *Electrical Shock Hazard. During Auto-Tuning, the motor will receive high voltage when the motor is stopped. Do not touch the motor until Auto-Tuning is complete. If you touch a motor that is energized, it can cause serious injury or death.*

■ Precautions before Using Deceleration Rate Tuning and KEB Tuning

Before Deceleration Rate Tuning or KEB Tuning, check these items:

Note:

- Do not do Deceleration Rate Tuning if you use a braking resistor unit or a regenerative converter.
- Do Deceleration Rate Tuning and KEB Tuning with the load attached to the motor.
- Do not do Deceleration Rate Tuning or KEB Tuning for these applications:
In Deceleration Rate Tuning and KEB Tuning, the drive will automatically rotate the motor forward and accelerate and decelerate the motor again and again.
 - On a machine that does not let the motor rotate forward
 - In applications with a small range of operation (trolleys and other such applications that can only move linearly)
 - Applications where sudden acceleration and sudden deceleration are not applicable.
- To do KEB Tuning with the external main circuit capacitors connected to the drive, set $L3-26$ [*Additional DC Bus Capacitors*] then do KEB Tuning.
- Do not do KEB Tuning or Deceleration Rate Tuning if the drive is set to use $H1-xx = 16$ [*MFDI Function Select = Motor 2 Selection*]. Failure to obey can cause an *ov* [*Overvoltage*] fault.

12 Drive Start-Up

◆ Set up the Drive with General-Purpose Setup Mode

Drive parameters are in letter groups from A to U. Setup Mode **SFUP** contains only the most frequently used parameters to help you set up the drive more easily.

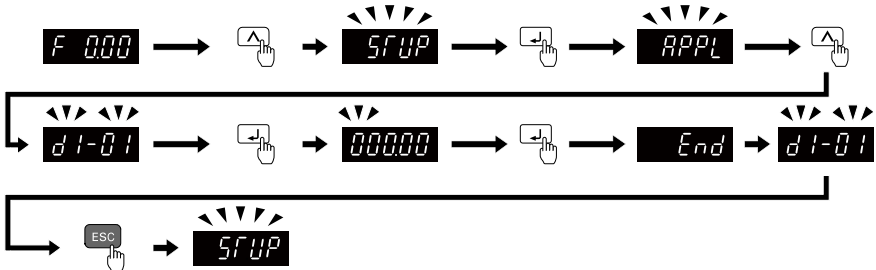

Figure 12.1 Parameters in General-Purpose Setup Mode

Table 12.1 shows the parameters available in Setup Mode. To access parameters not shown in the Setup Mode, use the **PRr** menu.

Table 12.1 Parameters in General-Purpose Setup Mode

User Parameter	Parameter	Name
A2-01	A1-02	Control Method Selection
A2-02	b1-01	Frequency Reference Selection 1
A2-03	b1-02	Run Command Selection 1
A2-04	b1-03	Stopping Method Selection
A2-05	C1-01	Acceleration Time 1
A2-06	C1-02	Deceleration Time 1
A2-07	C6-01	Normal / Heavy Duty Selection
A2-08	C6-02	Carrier Frequency Selection
A2-09	d1-01	Reference 1
A2-10	d1-02	Reference 2
A2-11	d1-03	Reference 3

User Parameter	Parameter	Name
A2-12	d1-04	Reference 4
A2-13	d1-17	Jog Reference
A2-14	E1-01	Input AC Supply Voltage
A2-15	E1-03	V/f Pattern Selection
A2-16	E1-04	Maximum Output Frequency
A2-17	E1-05	Maximum Output Voltage
A2-18	E1-06	Base Frequency
A2-19	E1-09	Minimum Output Frequency
A2-20	E1-13	Base Voltage
A2-21	E2-01	Motor Rated Current (FLA)
A2-22	E2-04	Motor Pole Count
A2-23	E2-11	Motor Rated Power
A2-24	H4-02	Terminal AM Analog Output Gain
A2-25	L1-01	Motor Overload (oL1) Protection
A2-26	L3-04	Stall Prevention during Decel

Note:

- When you change *A1-02 [Control Mode Selection]*, the settings of some parameters automatically change.
- This manual also shows parameters that are not in Setup Mode. Use  to set the parameters not shown in the Setup Mode.
- Display parameters change when the *A1-06 [Application Preset]* setting changes.

◆ Set and View Necessary Parameters

Show the frequency reference screen.

Note:

Push and hold  to return to frequency reference screen from any screen.

The setup mode shows the parameters set in *A2-01 to A2-32 [User Parameter 1 to User Parameter 32]*. This lets you quickly access and change these parameters.

Note:

Setup mode always shows **APPL** (A1-06 [Application Preset]) at the top of the list. When you change the setting, the settings for A2-01 to A2-32 change.

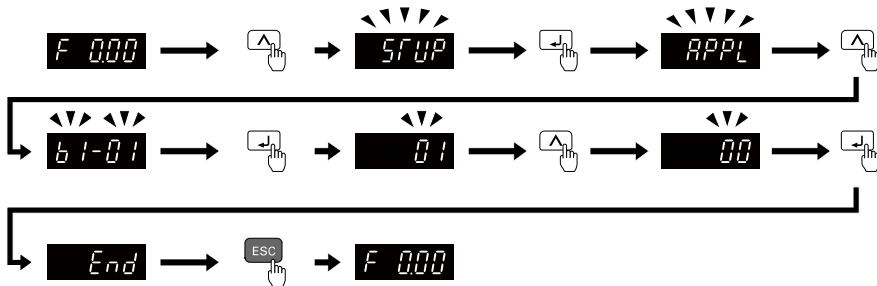

Figure 12.2 View and Set the Necessary Parameters

Continue to change the parameters or press and hold **ESC** to go back to the frequency reference screen.

◆ **Automatic Parameter Settings Optimized for Specific Applications (Application Presets)**

Show the frequency reference screen.

Note:

Press and hold **ESC** to return to the frequency reference screen from any screen.

Use this procedure to set an application preset.

The drive has application presets to set the necessary parameters for different applications

to their best values. Use **urFY** to find parameters that were changed automatically by the application preset function in A1-06.

Note:

Before you set A1-06, make sure that you set A1-03 = 2220, 3330 [Initialize Parameters = 2-Wire Initialization, 3-Wire Initialization] to initialize parameters.

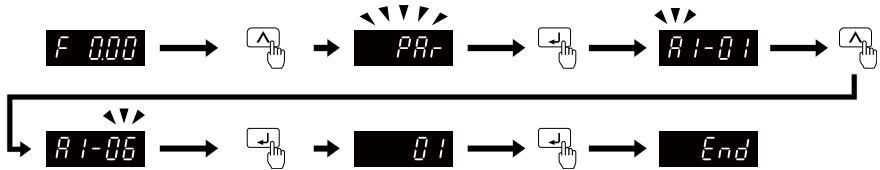

Figure 12.3 Automatic Parameter Settings

Press and hold **ESC** to go back to the frequency reference screen.

Note:

- You cannot directly set parameter *A1-06*. To set an application preset, first set *A1-03* = 2220 to initialize parameters, then set this parameter. If initializing all parameters will cause a problem, do not change the settings.
- When the drive applies the *A1-06* setting, it will also reset the parameters automatically registered to *A2-17* to *A2-32* [*User Parameters 17 to 32*] when *A2-33* = 1 [*User Parameter Auto Selection = Enabled: Auto Save Recent Params*].

13 Maintenance

Refer to the Maintenance & Troubleshooting Manual (TOEPYAIGA5001) for more information.

Only let authorized persons do maintenance, examine, or replace components on the drive.

Read this manual carefully and know all the precautions and safety information before installing, wiring, repairing, or examining the drive or replacing components.

Examine and maintain the drive and peripheral devices regularly to extend the life of the drive and decrease performance deterioration, decrease early wear, and decrease drive failures.

Regular examinations and maintenance will also decrease system downtime.

Refer to the Technical Reference (SIEPC71061752) for more information about maintenance and examinations.

Examine the drive one time each year at a minimum.

The operating conditions, environmental conditions, and use conditions will have an effect on the examination frequency for connected equipment.

Examine the drive more frequently if you use the drive in bad conditions or in these conditions:

- High ambient temperatures
- Frequent starting and stopping
- Changes in the AC power supply or load

- Too much vibration or shock loading
- Dust, metal dust, salt, sulfuric acid, or chlorine atmospheres
- Unsatisfactory storage conditions.

The drive has Maintenance Monitors that keep track of component wear and warn maintenance period when the estimated performance life is approaching. This Maintenance Monitor eliminates the need to shut down the entire system for unexpected problems.

Users can set alarm notifications to inform the maintenance periods for a specific drive component.

◆ Part Replacement Guidelines

Table 13.1 shows the standard replacement period for replacement parts. When you replace these parts, make sure that you use Yaskawa replacement parts for the applicable model and design revision number of your drive.

Table 13.1 Standard Replacement Period

Parts	Standard Replacement Period
Electrolytic Capacitor	10 years *1

*1 If there is damage to parts that you cannot repair or replace, replace the drive.

Note:

Performance life estimate is based on these use conditions. These conditions are provided for the purpose of replacing parts to maintain performance. Unsatisfactory conditions or heavy use will make it necessary for you to replace some parts more frequently than other parts.

- Ambient temperature: Yearly average of 35 °C (95 °F)
- Load factor: 80%
- Operating rate: 24 hours a day

14 Drive Control, Duty Modes, and Programming

◆ Control Method Selection

This section gives basic information about the control methods for induction motors.

- V/f Control
- Open Loop Vector
- EZ Vector Control

Refer to the Technical Reference for information about the control method for a PM/SynR motor.

Select the most applicable control method for your application. Parameter *A1-02 [Control Method Selection]* sets drive control.

Control Methods	A1-02	Main Applications
V/f	0	<ul style="list-style-type: none"> Use for main variable-speed applications, especially when you operate more than one motor with one drive. Use also when you do not have sufficient data to set the motor parameters.
OLV	2 (Default)	<ul style="list-style-type: none"> Main Applications of Variable Speed Control Use for applications in which high-precision and high performance are necessary and you do not use speed feedback.
EZOLV	8	<ul style="list-style-type: none"> Main Applications of Variable Speed Control Use for applications in which high-precision and high performance are not necessary and you do not use speed feedback.

◆ Drive Duty Modes

The drive has two duty modes from which to select for the application: Heavy Duty (HD) and Normal Duty (ND).

Refer to [Table 14.1](#) for information about the differences between HD and ND ratings.

Table 14.1 Drive Duty Modes

Duty Rating	C6-01 Setting	Application	Default Carrier Frequency	Overload Tolerance (oL2 [Drive Overload])
Heavy Duty Rating (HD)	0	<ul style="list-style-type: none"> Extruder Conveyor Cranes Constant torque or high overload capacity 	Determined by o2-04, A1-02	150% of the rated output current for 60 seconds The permitted frequency of overload is one time each 10 minutes.
Normal Duty Rating (ND)	1	<ul style="list-style-type: none"> Fan Pump Blower Variable speed control 	Determined by o2-04, A1-02	110% of the rated output current for 60 seconds The permitted frequency of overload is one time each 10 minutes.

◆ Auto-Tuning for Induction Motors

This section gives information about Auto-Tuning for induction motors. Set motor parameters *E1-xx* and *E2-xx* (or, for motor 2, *E3-xx* and *E4-xx*) for Auto-Tuning.

Note:

Do Stationary Auto-Tuning if you cannot do Rotational Auto-Tuning. There can be large differences between the measured results and the motor characteristics when Auto-Tuning is complete. Examine the parameters for the measured motor characteristics after you do Stationary Auto-Tuning.

Table 14.2 Auto-Tuning Mode Selection

Method	Parameter Settings	Application Conditions and Benefits	Applicable Control Method (A1-02 Setting)	
			V/f (0)	OLV (2)
Rotational Auto-Tuning	T1-01 = 0	<ul style="list-style-type: none"> When you can decouple the motor and load the motor can rotate freely while Auto-Tuning. When operating motors that have fixed output characteristics. When it is necessary to use motors that have high-precision control. When you cannot decouple the motor and load, but the motor load is less than 30%. 	x	x
Stationary Auto-Tuning 1	T1-01 = 1	<ul style="list-style-type: none"> When you cannot decouple the motor and load. When the motor load is more than 30%. When the information from the motor test report or motor nameplate is not available. With Stationary Auto-Tuning, the energized drive stays stopped for approximately 1 minute. During this time, the drive automatically measures the necessary motor parameters. When you operate the motor with less than 30% load after Auto-Tuning. Set $T1-12 = 1$ [<i>Test Mode Selection = Yes</i>] to do a test run after Auto-Tuning. 	-	x
Stationary Line-Line Resistance	T1-01 = 2	<ul style="list-style-type: none"> After Auto-Tuning, the wiring distance between the drive and motor changed by 50 m or more. When the wiring distance is 50 m or more in the V/f Control mode. When the motor output and drive capacity are different. 	x	x

■ Input Data for Induction Motor Auto-Tuning

To do Auto-Tuning, input data for the items in [Table 14.3](#) that have an "x". Before you start Auto-Tuning, prepare the motor test report or record the information from the motor nameplate as a reference.

Table 14.3 Input Data for Induction Motor Auto-Tuning

Input Data	Parameter	Unit	Auto-Tuning Mode (T1-01 Setting)		
			Rotational Auto-Tuning (0)	Stationary Auto-Tuning 1 (1)	Stationary Line-Line Resistance (2)
Motor Rated Power	T1-02	kW	x	x	x
Motor Rated Voltage	T1-03	V	x	x	-
Motor Rated Current	T1-04	A	x	x	x
Motor Base Frequency	T1-05	Hz	x	x	-
Number of Motor Poles	T1-06	-	x	x	-
Motor Base Speed	T1-07	min ⁻¹	x	x	-
Motor No-Load Current	T1-09	A	-	x	-
Motor Rated Slip Frequency	T1-10	Hz	-	x *1	-
Motor Iron Loss	T1-11	W	x *2	-	-
Test Mode Selection *3	T1-12	-	-	x *4	-
No-Load Voltage	T1-13	V	x *5	x *5	-

*1 Shows 0 Hz as the default value. If you do not know the Motor Rated Slip Frequency, keep the setting at 0 Hz.





*2 Input this value when $A1-02 = 0$ [Control Method Selection = V/f].

*3 If $T1-12 = 1$ [Test Mode Selection = Yes], when you run the motor in Drive Mode for the first time after Auto-Tuning, the drive will automatically set E2-02 [Motor Rated Slip] and E2-03 [Motor No-Load Current].

*4 Input this value when $T1-10$ [Motor Rated Slip Frequency] = 0 Hz.

*5 Set the same value to No-Load Voltage as $T1-03$ [Motor Rated Voltage] to get the same characteristics using Yaskawa 1000-Series drives or other legacy models.

◆ Drive Parameters

Icon	Description
	The parameter is available when operating the drive with V/f Control.
	The parameter is available when operating the drive with Open Loop Vector Control.
	The parameter is available when operating the drive with Open Loop Vector Control for PM.
	The parameter is available when operating the drive with Advanced Open Loop Vector Control for PM.
	The parameter is available when operating the drive with EZ Open Loop Vector Control.
Hex.	Hexadecimal numbers that represent MEMOBUS addresses to change parameters over network communication.
RUN	You can change the parameter setting while the drive is running.

Note:

Gray icons identify parameters that are not available in the specified control method.

This section shows the most common parameters for applications. Refer to this table when you set parameters.

No. (Hex.)	Name	Description
A1-00 (0100) RUN	Language Selection	<p>V/f OLV OLV/PM AOLV/PM EZOLV</p> <p>Sets the language for the LCD keypad.</p> <p>0 : English 1 : Japanese 2 : German 3 : French 4 : Italian 5 : Spanish 6 : Portuguese 7 : Chinese 8 : Czech 9 : Russian 10 : Turkish 11 : Polish 12 : Greek 13 : Korean</p>
A1-02 (0102)	Control Method Selection	<p>V/f OLV OLV/PM AOLV/PM EZOLV</p> <p>Sets the control method for the drive application and the motor.</p> <p>0 : V/f Control 2 : Open Loop Vector 5 : PM Open Loop Vector 6 : PM Advanced Open Loop Vector 8 : EZ Vector Control</p>
A1-03 (0103)	Initialize Parameters	<p>V/f OLV OLV/PM AOLV/PM EZOLV</p> <p>Sets parameters to default values.</p> <p>0 : No Initialization 1110 : User Initialization 2220 : 2-Wire Initialization 3330 : 3-Wire Initialization</p>
b1-01 (0180)	Frequency Reference Selection 1	<p>V/f OLV OLV/PM AOLV/PM EZOLV</p> <p>Sets the input method for the frequency reference.</p> <p>0 : Keypad 1 : Analog Input 2 : Memobus/Modbus Communications 3 : Option PCB 4 : Pulse Train Input</p>

14 Drive Control, Duty Modes, and Programming

No. (Hex.)	Name	Description
b1-02 (0181)	Run Command Selection 1	<p>V/f OLV OLV/PM AOLV/PM EZOLV</p> <p>Sets the input method for the Run command. 0 : Keypad 1 : Analog Input 2 : Memobus/Modbus Communications 3 : Option PCB</p>
b1-03 (0182)	Stopping Method Selection	<p>V/f OLV OLV/PM AOLV/PM EZOLV</p> <p>Sets the method to stop the motor after removing a Run command or entering a Stop command. 0 : Ramp to Stop 1 : Coast to Stop 2 : DC Injection Braking to Stop 3 : Coast to Stop with Timer</p>
b1-04 (0183)	Reverse Operation Selection	<p>V/f OLV OLV/PM AOLV/PM EZOLV</p> <p>Sets the reverse operation function. Disable reverse operation in fan or pump applications where reverse rotation is dangerous. 0 : Reverse Enabled 1 : Reverse Disabled</p>
C1-01 (0200) RUN	Acceleration Time 1	<p>V/f OLV OLV/PM AOLV/PM EZOLV</p> <p>Sets the length of time to accelerate from zero to maximum output frequency.</p>
C1-02 (0201) RUN	Deceleration Time 1	<p>V/f OLV OLV/PM AOLV/PM EZOLV</p> <p>Sets the length of time to decelerate from maximum output frequency to zero.</p>
C2-01 (020B)	S-Curve Time @ Start of Accel	<p>V/f OLV OLV/PM AOLV/PM EZOLV</p> <p>Sets the S-curve acceleration time at start.</p>
C2-02 (020C)	S-Curve Time @ End of Accel	<p>V/f OLV OLV/PM AOLV/PM EZOLV</p> <p>Sets the S-curve acceleration time at completion.</p>
C2-03 (020D)	S-Curve Time @ Start of Decel	<p>V/f OLV OLV/PM AOLV/PM EZOLV</p> <p>Sets the S-curve deceleration time at start.</p>
C2-04 (020E)	S-Curve Time @ End of Decel	<p>V/f OLV OLV/PM AOLV/PM EZOLV</p> <p>Sets the S-curve deceleration time at completion.</p>
C6-01 (0223)	Normal / Heavy Duty Selection	<p>V/f OLV OLV/PM AOLV/PM EZOLV</p> <p>Sets the drive duty rating. 0 : Heavy Duty Rating 1 : Normal Duty Rating</p>

No. (Hex.)	Name	Description
C6-02 (0224)	Carrier Frequency Selection	<p>V/f OLV OLV/PM AOLV/PM EZOLV</p> <p>Sets the carrier frequency for the transistors in the drive.</p> <p>1 : 2.0 kHz 2 : 5.0 kHz (4.0 kHz for AOLV/PM) 3 : 8.0 kHz (6.0 kHz for AOLV/PM) 4 : 10.0 kHz (8.0 kHz for AOLV/PM) 5 : 12.5 kHz (10.0 kHz for AOLV/PM) 6 : 15.0 kHz (12.0 kHz AOLV/PM) 7 : Swing PWM4 (Audible Sound 1) 8 : Swing PWM4 (Audible Sound 2) 9 : Swing PWM4 (Audible Sound 3) A : Swing PWM4 (Audible Sound 4) B : Leakage Current Rejection PWM F : User Defined (C6-03 to C6-05)</p>
d1-01 - d1-16 (0280 - 0291) RUN	Reference 1 to 16	<p>V/f OLV OLV/PM AOLV/PM EZOLV</p> <p>Sets the frequency reference in the units from 01-03 [<i>Frequency Display Unit Selection</i>].</p>
d1-17 (0292) RUN	Jog Reference	<p>V/f OLV OLV/PM AOLV/PM EZOLV</p> <p>Sets the Jog frequency reference in the units from 01-03 [<i>Frequency Display Unit Selection</i>]. Set H1-xx = 6 [<i>MFDI Function Select = Jog Reference Selection</i>] to use the Jog frequency reference.</p>
d2-01 (0289)	Frequency Reference Upper Limit	<p>V/f OLV OLV/PM AOLV/PM EZOLV</p> <p>Sets maximum limit for all frequency references. The maximum output frequency is 100%.</p>
d2-02 (028A)	Frequency Reference Lower Limit	<p>V/f OLV OLV/PM AOLV/PM EZOLV</p> <p>Sets minimum limit for all frequency references. The maximum output frequency is 100%.</p>
E1-01 (0300)	Input AC Supply Voltage	<p>V/f OLV OLV/PM AOLV/PM EZOLV</p> <p>Sets the drive input voltage.</p>
E1-04 (0303)	Maximum Output Frequency	<p>V/f OLV OLV/PM AOLV/PM EZOLV</p> <p>Sets the maximum output frequency for the V/f pattern.</p>
E1-05 (0304)	Maximum Output Voltage	<p>V/f OLV OLV/PM AOLV/PM EZOLV</p> <p>Sets the maximum output voltage for the V/f pattern.</p>
E1-06 (0305)	Base Frequency	<p>V/f OLV OLV/PM AOLV/PM EZOLV</p> <p>Sets the base frequency for the V/f pattern.</p>

14 Drive Control, Duty Modes, and Programming

No. (Hex.)	Name	Description
E1-09 (0308)	Minimum Output Frequency	<input type="checkbox"/> V/f <input type="checkbox"/> OLV <input type="checkbox"/> OLV/PM <input type="checkbox"/> AOLV/PM <input type="checkbox"/> EZOLV Sets the minimum output frequency for the V/f pattern.
E2-01 (030E)	Motor Rated Current (FLA)	<input type="checkbox"/> V/f <input type="checkbox"/> OLV <input type="checkbox"/> OLV/PM <input type="checkbox"/> AOLV/PM <input type="checkbox"/> EZOLV Sets the motor rated current in amps.
E2-11 (0318)	Motor Rated Power	<input type="checkbox"/> V/f <input type="checkbox"/> OLV <input type="checkbox"/> OLV/PM <input type="checkbox"/> AOLV/PM <input type="checkbox"/> EZOLV Sets the motor rated output in the units from 01-58 [Motor Power Unit Selection].
H1-01 - H1-07 (0438, 0439, 0400 - 0404)	Terminal S1 to S7 Function Selection	<input type="checkbox"/> V/f <input type="checkbox"/> OLV <input type="checkbox"/> OLV/PM <input type="checkbox"/> AOLV/PM <input type="checkbox"/> EZOLV Sets the function for MFDO terminals S1 to S7.
H2-01 (040B)	Term MA/MB-MC Function Selection	<input type="checkbox"/> V/f <input type="checkbox"/> OLV <input type="checkbox"/> OLV/PM <input type="checkbox"/> AOLV/PM <input type="checkbox"/> EZOLV Sets the function set for MFDO terminal MA-MC or MB-MC.
H2-02 (040C)	Term P1-C1 Function Selection	<input type="checkbox"/> V/f <input type="checkbox"/> OLV <input type="checkbox"/> OLV/PM <input type="checkbox"/> AOLV/PM <input type="checkbox"/> EZOLV Sets the function for MFDO terminal P1-C1.
H2-03 (040D)	Term P2-C2 Function Selection	<input type="checkbox"/> V/f <input type="checkbox"/> OLV <input type="checkbox"/> OLV/PM <input type="checkbox"/> AOLV/PM <input type="checkbox"/> EZOLV Sets the function for MFDO terminal P2-C2.
H3-01 (0410)	Terminal A1 Signal Level Select	<input type="checkbox"/> V/f <input type="checkbox"/> OLV <input type="checkbox"/> OLV/PM <input type="checkbox"/> AOLV/PM <input type="checkbox"/> EZOLV Sets the input signal level for MFAI terminal A1. 0 : 0 to 10V (Lower Limit at 0) 4 : -10 to +10V (Bipolar Reference)
H3-02 (0434)	Terminal A1 Function Selection	<input type="checkbox"/> V/f <input type="checkbox"/> OLV <input type="checkbox"/> OLV/PM <input type="checkbox"/> AOLV/PM <input type="checkbox"/> EZOLV Sets the function for MFAI terminal A1.
H3-03 (0411) RUN	Terminal A1 Gain Setting	<input type="checkbox"/> V/f <input type="checkbox"/> OLV <input type="checkbox"/> OLV/PM <input type="checkbox"/> AOLV/PM <input type="checkbox"/> EZOLV Sets the gain of the analog signal input to MFAI terminal A1.
H3-04 (0412) RUN	Terminal A1 Bias Setting	<input type="checkbox"/> V/f <input type="checkbox"/> OLV <input type="checkbox"/> OLV/PM <input type="checkbox"/> AOLV/PM <input type="checkbox"/> EZOLV Sets the bias of the analog signal input to MFAI terminal A1.
H3-09 (0417)	Terminal A2 Signal Level Select	<input type="checkbox"/> V/f <input type="checkbox"/> OLV <input type="checkbox"/> OLV/PM <input type="checkbox"/> AOLV/PM <input type="checkbox"/> EZOLV Sets the input signal level for MFAI terminal A2. 0 : 0-10V (LowLim=0) 2 : 4 to 20 mA 3 : 0 to 20 mA 4 : -10 to +10V (Bipolar Reference)

No. (Hex.)	Name	Description
H3-10 (0418)	Terminal A2 Function Selection	V/f OLV OLV/PM AOLV/PM EZOLV Sets the function for MFAI terminal A2.
H3-11 (0419) RUN	Terminal A2 Gain Setting	V/f OLV OLV/PM AOLV/PM EZOLV Sets the gain of the analog signal input to MFAI terminal A2.
H3-12 (041A) RUN	Terminal A2 Bias Setting	V/f OLV OLV/PM AOLV/PM EZOLV Sets the bias of the analog signal input to MFAI terminal A2.
H3-13 (041B)	Analog Input FilterTime Constant	V/f OLV OLV/PM AOLV/PM EZOLV Sets the time constant for primary delay filters on MFAI terminals.
H3-14 (041C)	Analog Input Terminal Enable Sel	V/f OLV OLV/PM AOLV/PM EZOLV Sets the enabled terminal or terminals when $H1-xx = C$ [MFDI Function Select = Analog Terminal Enable Selection] is ON. 1 : Terminal A1 only 2 : Terminal A2 only 7 : Terminals A1 and A2
H4-01 (041D)	Terminal AM Analog Output Select	V/f OLV OLV/PM AOLV/PM EZOLV Sets the monitoring number to be output from the MFAO terminal AM.
H4-02 (041E) RUN	Terminal AM Analog Output Gain	V/f OLV OLV/PM AOLV/PM EZOLV Sets the gain of the monitor signal that is sent from MFAO terminal AM.
H4-03 (041F) RUN	Terminal AM Analog Output Bias	V/f OLV OLV/PM AOLV/PM EZOLV Sets the bias of the monitor signal that is sent from MFAO terminal AM.
H4-07 (0423)	Terminal AM Signal Level Select	V/f OLV OLV/PM AOLV/PM EZOLV Sets the MFAO terminal AM output signal level. 0 : 0-10V 2 : 4 to 20 mA
L1-01 (0480)	Motor Overload (oL1) Protection	V/f OLV OLV/PM AOLV/PM EZOLV Sets the motor overload protection with electronic thermal protectors. 0 : No 1 : Variable Torque 2 : Constant Torque 10:1 Speed Range 3 : Constant Torque 100:1 SpeedRange 4 : PM Variable Torque 5 : PM Constant Torque 6 : Variable Torque (50Hz)

No. (Hex.)	Name	Description
L1-02 (0481)	Motor Overload Protection Time	<p>V/f OLV OLV/PM AOLV/PM EZOLV</p> <p>Sets the operation time for the electronic thermal protector of the drive to prevent damage to the motor. Usually it is not necessary to change this setting.</p>
L3-04 (0492)	Stall Prevention during Decel	<p>V/f OLV OLV/PM AOLV/PM EZOLV</p> <p>Sets the method that the drive will use to prevent overvoltage faults when decelerating.</p> <p>0 : No 1 : General Purpose 2 : Intelligent (Ignore Decel Ramp) 3 : General Purpose w/ DB resistor 4 : Overexcitation/High Flux 5 : Overexcitation/High Flux 2 7 : Overexcitation/High Flux 3</p>

15 Troubleshooting

If the drive or motor do not operate correctly, look at the drive keypad for fault and alarm information.

- For drive faults:
 - The keypad shows the fault code.
 - ALM/ERR LED stays illuminated.
 - The drive shuts off output, and the output terminal set for *Fault [H2-01 to H2-03 = E]* activates. The motor coasts to stop.
- For drive alarms:
 - The keypad shows the alarm code.
 - The ALM/ERR LED flashes.
 - Usually, the drive will continue to operate the motor. Some alarms let you select a motor stopping method.

◆ Fault Reset Procedure with the Keypad

1. Remove the cause of the alarm or fault.
2. While the keypad is showing the fault or alarm code, push  on the keypad.

◆ Fault

This section gives information about some of the causes and possible solutions of faults. You must use the Fault Reset operation to remove the fault before you can operate the drive. Use the information in this table to remove the cause of the fault.

Code	Name	Causes	Possible Solutions
bAT	Keypad Battery Low Voltage	The keypad battery voltage is low.	Replace the keypad battery.
bCE	Bluetooth Communication Fault	The smartphone or tablet with DriveWizard Mobile installed is too far from the keypad.	Use the smartphone or tablet 10 m (32.8 ft) or nearer to the keypad. Note: <i>bCE</i> can occur when the smartphone or tablet is 10 m (32.8 ft) or nearer to the keypad depending on the specifications of the smartphone or tablet.
		Radio waves from a different device are causing interference with communications between the smartphone or tablet and keypad.	Make sure that no device around the keypad uses the same radio bandwidth (2400 MHz to 2480 MHz), and prevent radio interference.
boL	Braking Transistor Overload Fault	The duty cycle of the braking transistor is high (the regeneration power or repetition frequency is high).	<ul style="list-style-type: none"> Install a regenerative converter. Increase the deceleration time.
		You enabled the protective function for the braking transistor when you have a regenerative converter.	Set $L8-55 = 0$ [<i>Internal DB TransistorProtection Selection = Disable</i>].
		The braking transistor in the drive is broken.	Replace the drive.
bUS	Option Communication Error	The drive did not receive a signal from the controller.	Correct wiring errors.
		The communications cable wiring is incorrect.	
		There is a short-circuit in the communications cable or the communications cable is not connected.	<ul style="list-style-type: none"> Repair short circuits and connect cables. Replace the defective communications cable.

Code	Name	Causes	Possible Solutions
		Electrical interference caused a communication data error.	<ul style="list-style-type: none"> Examine the control circuit lines, main circuit lines, and ground wiring, and decrease the effects of electrical interference. Make sure that a magnetic contactor is not the source of the electrical interference, then use a Surge Protective Device if necessary. Use only the recommended cables or other shielded line. Ground the shield on the controller side or the drive input power side. Separate the communication wiring from drive power lines, and install a noise filter to the input side of the power supply for communication. Decrease the effects of electrical interference from the controller.
		The option is incorrectly installed to the drive.	Correctly install the option to the drive.
		The option is damaged.	If the fault continues and the wiring is correct, replace the option.
CE	Modbus Communication Error	The communications cable wiring is incorrect.	Correct wiring errors.
		There is a short circuit in the communications cable or the communications cable is not connected.	<ul style="list-style-type: none"> Repair short circuits and connect cables. Replace the defective communications cable.
		Electrical interference caused a communication data error.	<ul style="list-style-type: none"> Examine the control circuit lines, main circuit lines, and ground wiring, and decrease the effects of electrical interference. Make sure that a magnetic contactor is not the source of the electrical interference, then use a Surge Protective Device if necessary. Use only the recommended cables or other shielded line. Ground the shield on the controller side or the drive input power side. Separate the communication wiring from drive power lines, and install a noise filter to the input side of the power supply for communication. Decrease the effects of electrical interference from the controller.
CF	Control Fault	Motor parameters are set incorrectly	Correctly set the motor parameters and do Auto-Tuning again.

Code	Name	Causes	Possible Solutions
		The torque limit setting is too low.	Adjust L7-01 to L7-04 [Torque Limit].
		The load inertia is too large.	<ul style="list-style-type: none"> Adjust C1-02, C1-04, C1-06, and C1-08 [Deceleration Times]. Set the frequency reference to the minimum output frequency, and stop the Run command when the drive stops deceleration.
		The drive is trying to ramp to stop a machine that cannot do ramp to stop or on a machine for which deceleration is not necessary.	Correctly set b1-03 [Stopping Method Selection].
		The motor and drive are connected incorrectly.	Correct wiring errors.
		Line-to-line Resistance Tuning is not done.	Do Stationary Auto-Tuning for Line-to-Line Resistance.
		The drive received a Run command while the motor was coasting.	<ul style="list-style-type: none"> Examine the sequence and input the Run command after the motor fully stops. Set b3-01 = 1 [Speed Search at Start Selection = Enabled].
CoF	Current Offset Fault	The drive starts operation while the induced voltage stays in the motor (during coasting to a stop or after fast deceleration).	<ul style="list-style-type: none"> Make a sequence that does not restart operation when induced voltage stays in the motor. Set b3-01 = 1 [Speed Search at Start Selection = Enabled]. Use Speed Search from Fmax or Fref [H1-xx = 61, 62] to do a speed search through one of the external terminals. <p>Note: When controlling the PM motor, External Speed Search commands 1 and 2 operate the same.</p>
		A drive hardware problem occurred.	Replace the drive.
CP1	Comparator 1 Limit Error	The monitor value set in H2-20 [Comparator 1 Monitor Selection] was in the range of H2-21 [Comparator 1 Lower Limit] and H2-22 [Comparator 1 Upper Limit].	Examine the monitor value and remove the cause of the fault.

Code	Name	Causes	Possible Solutions
CP2	Comparator 2 Limit Error	The monitor value set in H2-26 [Comparator 2 Monitor Selection] was outside the range of H2-27 [Comparator 2 Lower Limit] and H2-28 [Comparator 2 Upper Limit].	Examine the monitor value and remove the cause of the fault.
CPF00, CPF01, CPF02, CPF03, CPF08, CPF11 - CPF14, CPF16 - CPF24, CPF38	Control Circuit Error	A drive hardware problem occurred.	<ul style="list-style-type: none"> Re-energize the drive. If the fault stays, replace the control board or the drive. For information about replacing the control board, contact Yaskawa or your nearest sales representative.
CPF06	Control Circuit Error (EEPROM memory Data Error)	The drive power supply was de-energized while a communication option entered a parameter Write command.	Set A1-03 = 2220, 3330 [Initialize Parameters = 2-Wire Initialization, 3-Wire Initialization] and initialize the drive.
		An EEPROM peripheral circuit error occurred.	<ul style="list-style-type: none"> Re-energize the drive. If the fault stays, replace the control board or the drive. For information about how to replace the control board, contact Yaskawa or your nearest sales representative.
dCE1	Communication Error1	A drive hardware problem occurred temporarily due to noise.	<ul style="list-style-type: none"> Remove the cause of the noise. If the fault stays, replace the control board or the drive.
dCE2	Communication Error2	A drive hardware problem occurred temporarily due to noise.	<ul style="list-style-type: none"> Remove the cause of the noise. If the fault stays, replace the control board or the drive.
dEv	Speed Deviation	The load is too heavy.	Decrease the load.
		Acceleration and deceleration times are set too short.	Increase the values set in C1-01 to C1-08 [Acceleration/Deceleration Time].
		The dEv detection level settings are incorrect.	Adjust F1-10 [Speed Deviation Detection Level] and F1-11 [Speed Deviation Detect DelayTime].
		The load is locked up.	Examine the machine.
		The holding brake is stopping the motor.	Release the holding brake.
dv7	Polarity Judge Timeout	There is a disconnection in the motor coil winding.	Measure the motor line-to-line resistance and replace the motor if a coil is disconnected.

Code	Name	Causes	Possible Solutions
		The screws on the drive output terminals are loose.	Tighten the terminal screws to the correct tightening torque.
dWF1	EEPROM Memory DWEZ Data Error	There is an error in the EEPROM peripheral circuit.	<ul style="list-style-type: none"> Re-energize the drive. If the fault stays, replace the control board or the drive. For information about replacing the control board, contact Yaskawa or your nearest sales representative.
		There is a problem with the EEPROM data.	Set <i>A1-03 = 2220, 3330</i> [<i>Initialize Parameters = 2-Wire Initialization, 3-Wire Initialization</i>] to initialize the drive, then upload the DriveWorksEZ project to the drive again.
dWF2	DriveWorksEZ Fault 2	There was a fault in the DriveWorksEZ program.	Examine the DriveWorksEZ program and remove the cause of the fault. This is not a drive fault.
dWF3	DriveWorksEZ Fault 3	There was a fault in the DriveWorksEZ program.	Examine the DriveWorksEZ program and remove the cause of the fault. This is not a drive fault.
dWFL	DriveWorksEZ Fault	There was a fault in the DriveWorksEZ program.	Examine the DriveWorksEZ program and remove the cause of the fault. This is not a drive fault.
E5	MECHATROLINK Watchdog Timer Err	The drive detected a watchdog circuit exception while it received data from the controller.	<p>Examine the MECHATROLINK cable connection. If this error occurs frequently, examine the wiring and decrease the effects of electrical interference as specified by these manuals:</p> <ul style="list-style-type: none"> MECHATROLINK-II Installation Guide (MECHATROLINK Members Association, manual number MMATDEP011) MECHATROLINK-III Installation Manual (MECHATROLINK Members Association, publication number MMATDEP018)
EF0	Option Card External Fault	The communication option received an external fault from the controller.	<ol style="list-style-type: none"> Find the device that caused the external fault and remove the cause. Clear the external fault input from the controller.
		A programming error occurred on the controller side.	Examine the operation of the controller program.
EF1	External Fault (Terminal S1)	MFDI terminal S1 caused an external fault through an external device.	<ol style="list-style-type: none"> Find the device that caused the external fault and remove the cause. Clear the external fault input in the MFDI.

Code	Name	Causes	Possible Solutions
		The wiring is incorrect.	Correctly connect the signal line to MFDI terminal S1.
		<i>External Fault [H1-01 = 20 to 2B] is set to MFDI terminal S1, but the terminal is not in use.</i>	Correctly set the MFDI.
EF2	External Fault (Terminal S2)	MFDI terminal S2 caused an external fault through an external device.	<ol style="list-style-type: none"> 1. Find the device that caused the external fault and remove the cause. 2. Clear the external fault input in the MFDI.
		The wiring is incorrect.	Correctly connect the signal line to MFDI terminal S2.
		<i>External Fault [H1-02 = 20 to 2B] is set to MFDI terminal S2, but the terminal is not in use.</i>	Correctly set the MFDI.
EF3	External Fault (Terminal S3)	MFDI terminal S3 caused an external fault through an external device.	<ol style="list-style-type: none"> 1. Find the device that caused the external fault and remove the cause. 2. Clear the external fault input in the MFDI.
		The wiring is incorrect.	Correctly connect the signal line to MFDI terminal S3.
		<i>External Fault [H1-03 = 20 to 2B] is set to MFDI terminal S3, but the terminal is not in use.</i>	Correctly set the MFDI.
EF4	External Fault (Terminal S4)	MFDI terminal S4 caused an external fault through an external device.	<ol style="list-style-type: none"> 1. Find the device that caused the external fault and remove the cause. 2. Clear the external fault input in the MFDI.
		The wiring is incorrect.	Correctly connect the signal line to MFDI terminal S4.
		<i>External Fault [H1-04 = 20 to 2B] is set to MFDI terminal S4, but the terminal is not in use.</i>	Correctly set the MFDI.
EF5	External Fault (Terminal S5)	MFDI terminal S5 caused an external fault through an external device.	<ol style="list-style-type: none"> 1. Find the device that caused the external fault and remove the cause. 2. Clear the external fault input in the MFDI.
		The wiring is incorrect.	Correctly connect the signal line to MFDI terminal S5.
		<i>External Fault [H1-05 = 20 to 2B] is set to MFDI terminal S5, but the terminal is not in use.</i>	Correctly set the MFDI.

Code	Name	Causes	Possible Solutions
EF6	External Fault (Terminal S6)	MFDI terminal S6 caused an external fault through an external device.	<ol style="list-style-type: none"> 1. Find the device that caused the external fault and remove the cause. 2. Clear the external fault input in the MFDI.
		The wiring is incorrect.	Correctly connect the signal line to MFDI terminal S6.
		<i>External Fault [H1-06 = 20 to 2B] is set to MFDI terminal S6, but the terminal is not in use.</i>	Correctly set the MFDI.
EF7	External Fault (Terminal S7)	MFDI terminal S7 caused an external fault through an external device.	<ol style="list-style-type: none"> 1. Find the device that caused the external fault and remove the cause. 2. Clear the external fault input in the MFDI.
		The wiring is incorrect.	Correctly connect the signal line to MFDI terminal S7.
		<i>External Fault [H1-07 = 20 to 2B] is set to MFDI terminal S7, but the terminal is not in use.</i>	Correctly set the MFDI.
Err	EEPROM Write Error	There was a problem with the EEPROM hardware.	<ul style="list-style-type: none"> • Re-energize the drive. • If the fault stays, replace the control board or the drive. Contact Yaskawa or your nearest sales representative to replace the board.
		Electrical interference corrupted the data while it was writing to the EEPROM of the drive.	<ul style="list-style-type: none"> • Push ENTER Key. • Set the parameters again.
FbH	Excessive PID Feedback	The <i>FbH</i> detection level is set incorrectly.	Adjust <i>b5-36 [PID High Feedback Detection Lvl]</i> and <i>b5-37 [PID High Feedback Detection Time]</i> .
		There is a problem with the PID feedback wiring.	Correct errors with the PID control wiring.
		The feedback sensor is not operating correctly.	Examine the sensors on the control device side.
		A fault occurred in the feedback input circuit of the drive.	Replace the control board or the drive. For information about replacing the control board, contact Yaskawa or your nearest sales representative.
FbL	PID Feedback Loss	The <i>FbL</i> detection level is set incorrectly.	Adjust <i>b5-13 [PID Feedback Loss Detection Lvl]</i> and <i>b5-14 [PID Feedback Loss Detection Time]</i> .
		There is a problem with the PID feedback wiring.	Correct errors with the PID control wiring.

Code	Name	Causes	Possible Solutions
		The feedback sensor is not operating correctly.	Examine the sensors on the control device side.
		A fault occurred in the feedback input circuit of the drive.	Replace the control board or the drive. For information about replacing the control board, contact Yaskawa or your nearest sales representative.
GF	Ground Fault	Overheating caused damage to the motor or the motor insulation is not satisfactory.	Measure the motor insulation resistance, and replace the motor if there is electrical conduction or unserviceable insulation.
		The motor main circuit cable is contacting ground to make a short circuit.	<ul style="list-style-type: none"> Examine the motor main circuit cable for damage, and repair short circuits. Measure the resistance between the motor main circuit cable and the ground terminal. If there is electrical conduction, replace the cable.
		An increase in the stray capacitance of the cable and the ground terminal caused an increase in the leakage current.	<ul style="list-style-type: none"> If the wiring length of the cable is more than 100 m, decrease the carrier frequency. Decrease the stray capacitance.
		There was a problem with the drive hardware.	Replace the control board or the drive. For information about replacing the control board, contact Yaskawa or your nearest sales representative.
LF	Output Phase Loss	The motor main circuit cable is disconnected.	Connect motor main circuit cable wiring. Correct wiring errors in the main circuit drive input power.
		There is a disconnection in the motor coil winding.	If a coil is disconnected, measure the motor Line-to-Line Resistance and replace the motor.
		The screws on the drive output terminals are loose.	Tighten the terminal screws to the correct tightening torque.
		The rated output current of the motor is less than 5% of the drive rated current.	Examine the drive capacity or the motor output to be applied.
		You are trying to use a single-phase motor.	The drive cannot operate a single-phase motor.
		The output transistor in the drive is damaged.	<ul style="list-style-type: none"> Re-energize the drive. If the fault stays, replace the control board or the drive. For information about replacing the control board, contact Yaskawa or your nearest sales representative.
LF2	Output Current Imbalance	Phase loss occurred in the wiring on the output side of the drive.	Examine for wiring errors or disconnected wires on the output side of the drive, and repair problems.

Code	Name	Causes	Possible Solutions
		The output terminal screws of the drive are loose.	Tighten the terminal screws to the correct tightening torque.
		There is not balance between the three phases of the PM motor impedance.	<ul style="list-style-type: none"> • Measure the Line-to-Line Resistance for each motor phase and make sure that resistance is equal in the three phases, and that all wires are connected correctly. • Replace the motor.
		The drive output circuit is broken.	<ul style="list-style-type: none"> • Re-energize the drive. • If the fault stays, replace the control board or the drive. For information about replacing the control board, contact Yaskawa or your nearest sales representative.
LSo	Low Speed Motor Step-Out	The motor code set incorrectly.	<ul style="list-style-type: none"> • Set <i>E5-01 [PM Motor Code Selection]</i> correctly as specified by the motor. • For specialized motors, refer to the motor test report and set <i>E5-xx</i> correctly.
		The load is too large.	<ul style="list-style-type: none"> • Decrease the load. • Replace the drive and motor with larger capacity models.
		An external force on the load side caused the motor to move at start.	Find and repair problems on the load side that cause the motor to rotate from the load side.
		The drive incorrectly detected the motor magnetic pole position.	<ul style="list-style-type: none"> • Set <i>b3-01 = 1 [Speed Search at Start Selection = Enabled]</i>. • If the value for <i>U6-57 [PolePolarityDeterVal]</i> is lower than 819, increase the value set in <i>n8-84 [Polarity Detection Current]</i>. Consult the motor manufacturer for information about maximum setting values.
		The setting of <i>n8-84 [Polarity Detection Current]</i> is too low.	Increase the n8-84 setting from the default. Consult the motor manufacturer for information about maximum setting values.
		Incorrect values set in <i>L8-93 [Low Speed Pull-out DetectionTime]</i> , <i>L8-94 [Low Speed Pull-out Detect Level]</i> , and <i>L8-95 [Low Speed Pull-out Amount]</i> .	Increase the values set in <i>L8-93 to L8-95</i> .

Code	Name	Causes	Possible Solutions
		The drive incorrectly detected the motor magnetic pole position.	If you are using an IPM motor, do High Frequency Injection Auto-Tuning.
nSE	Node Setup Error	The H1-xx = 47 [Node Setup (CANopen)] terminal was activated during run.	Stop the drive when the Node Setup function is in use.
		The drive received a Run command while the Node Setup function was active.	
oC	Overcurrent	The load is too heavy.	<ul style="list-style-type: none"> Measure the current flowing into the motor. Replace the drive with a larger capacity model if the current value is more than the drive rated current. Decrease the load or replace with a larger drive to prevent sudden changes in the current level.
		Overheating caused damage to the motor or the motor insulation is not satisfactory.	Measure the motor insulation resistance, and replace the motor if there is electrical conduction or unserviceable insulation.
		The motor main circuit cable is contacting ground to make a short circuit.	<ul style="list-style-type: none"> Examine the motor main circuit cable for damage, and repair short circuits. Measure the resistance between the motor main circuit cable and the ground terminal. If there is electrical conduction, replace the cable.
		A short circuit or ground fault on the drive output side caused damage to the output transistor of the drive.	<ul style="list-style-type: none"> Make sure that there is not a short circuit in terminal B1 and terminals U/T1, V/T2, and W/T3. Make sure that there is not a short circuit in terminals - and terminals U/T1, V/T2, and W/T3. If there is a short circuit, contact Yaskawa or your nearest sales representative.
		The acceleration time is too short.	<ul style="list-style-type: none"> Calculate the torque necessary during acceleration related to the load inertia and the specified acceleration time. Increase the values set in C1-01, C1-03, C1-05, or C1-07 [Acceleration Times] to get the necessary torque. Increase the values set in C2-01 to C2-04 [S-Curve Characteristics] to get the necessary torque. Replace the drive with a larger capacity model.

Code	Name	Causes	Possible Solutions
		The drive is trying to operate a specialized motor or a motor that is larger than the maximum applicable motor output of the drive.	<ul style="list-style-type: none"> Examine the motor nameplate, the motor, and the drive to make sure that the drive rated current is larger than the motor rated current. Replace the drive with a larger capacity model.
		A magnetic contactor was switched at the output.	Set the operation sequence to not turn ON or OFF the magnetic contactor while the drive is outputting voltage.
		The V/f pattern settings are incorrect.	<ul style="list-style-type: none"> Examine the ratios between the V/f pattern frequency and voltage. Decrease the voltage if it is too high compared to the frequency. Adjust <i>E1-04</i> to <i>E1-10</i> [<i>V/f Pattern Parameters</i>]. For motor 2, adjust <i>E3-04</i> to <i>E3-10</i>.
		The torque compensation gain is too large.	Decrease the value set in <i>C4-01</i> [<i>Torque Compensation Gain</i>] to make sure that the motor does not stall.
		Electrical interference caused a problem.	Examine the control circuit lines, main circuit lines, and ground wiring, and decrease the effects of electrical interference.
		The gain during overexcitation operation is too large.	<ul style="list-style-type: none"> Find the time when the fault occurs. If the fault occurs at the same time as an overexcitation operation, decrease <i>n3-13</i> [<i>OverexcitationBraking (OEB) Gain</i>] and consider the motor flux saturation.
		The drive received a Run command while the motor was coasting.	<ul style="list-style-type: none"> Examine the sequence and input the Run command after the motor fully stops. Set <i>b3-01</i> = 1 [<i>Speed Search at Start Selection = Enabled</i>] or set <i>H1-xx</i> = 61, 62 [<i>Speed Search from Fmax or Fref</i>] to input speed search commands from the MFDI terminals.
		In PM Control Methods, the setting of the motor code is incorrect.	<ul style="list-style-type: none"> Enter the correct motor code to <i>E5-01</i> [<i>PM Motor Code Selection</i>] as specified by the PM motor. For specialized motors, refer to the motor test report and set <i>E5-xx</i> [<i>PM Motor Settings</i>] correctly.

Code	Name	Causes	Possible Solutions
		If the drive detects the fault at start or in the low speed range (10% or less) and $n8-57 = 1$ [<i>HFI Overlap Selection = Enabled</i>] for PM Control methods, the high frequency injection gain is too high.	<ul style="list-style-type: none"> Set <i>E5-xx [PM Motor Parameters]</i> correctly or do Rotational Auto-Tuning. Decrease the value of <i>n8-41 [HFI P Gain]</i> in 0.5-unit increments. <p>Note: Set $n8-41 > 0.0$ for an ordinary IPM motor.</p>
		The control method is set incorrectly for the motor.	Set <i>A1-02 [Control Method Selection]</i> correctly.
		The motor main circuit cable is too long.	<ul style="list-style-type: none"> Replace the drive with a larger capacity model. Decrease <i>C6-02 [Carrier Frequency]</i>. Or set $C6-02 = B$.
		Speed search does not complete at start when you set <i>A1-02 = 8 [EZ Vector Control]</i> and use an induction motor.	When <i>E9-01 = 0 [Motor Type Selection = Induction (IM)]</i> , set <i>b3-24 = 2 [Speed Search Method Selection = Current Detection Speed Search]</i> .
		An overcurrent occurred during overexcitation deceleration.	<ul style="list-style-type: none"> Decrease <i>n3-13 [OverexcitationBraking (OEB) Gain]</i>. Decrease <i>n3-21 [HSB Current Suppression Level]</i>.
oC2	Overcurrent2	When <i>A1-02 = 5, 6, 8 [Control Method Selection = OLV/PM, AOLV/PM, or EZOLV]</i> , the output current is more than the value set in <i>L8-27 [Overcurrent Detection Gain]</i> .	Correct the value set in <i>L8-27</i> .
oFA00	Option Not Compatible with Port	The option connected to connector CN5 is not compatible.	Connect a correct option.
oFA01	Option Fault/ Connection Error	You changed the option card connected to connector CN5 during operation.	<ol style="list-style-type: none"> De-energize the drive. Refer to the option card manual and correctly connect the option card to the connector on the drive.
oFA03 to oFA06	Option Card Error Occurred at Option Port (CN5)	A fault occurred in the option card.	<ol style="list-style-type: none"> De-energize the drive. Make sure that the option card is correctly connected to the connector. If the problem continues, replace the option card.
oFA10, oFA11	Option Card Error Occurred at Option Port (CN5)	A fault occurred in the option card.	<ol style="list-style-type: none"> De-energize the drive. Make sure that the option card is correctly connected to the connector. If the problem continues, replace the option card.

Code	Name	Causes	Possible Solutions
oFA12 to oFA17	Option Card Connection Error (CN5)	A fault occurred in the option card.	<ol style="list-style-type: none"> 1. De-energize the drive. 2. Make sure that the option card is correctly connected to the connector. 3. If the problem continues, replace the option card.
oFA30 to oFA43	Communication Option Card Connection Error (CN5)	A fault occurred in the option card.	<ol style="list-style-type: none"> 1. De-energize the drive. 2. Make sure that the option card is correctly connected to the connector. 3. If the problem continues, replace the option card.
oH	Heatsink Overheat	The ambient temperature is high and the heatsink temperature of the drive is more than the value set in L8-02 [<i>Overheat Alarm Level</i>].	<ul style="list-style-type: none"> • Measure the ambient temperature. • Increase the airflow in the control panel. • Install a cooling device (cooling fan or air conditioner) to lower the ambient temperature. • Remove objects near the drive that are producing too much heat.
		The load is too heavy.	<ul style="list-style-type: none"> • Measure the output current. • Decrease the load. • Decrease the value set in C6-02 [<i>Carrier Frequency Selection</i>].
		The internal cooling fan of the drive stopped.	<ol style="list-style-type: none"> 1. Use the procedures in this manual to replace the cooling fan. 2. Set o4-03 = 0 [<i>Fan Operation Time Setting = 0 h</i>].
oH1	Heatsink Overheat	The ambient temperature is high and the heatsink temperature of the drive is more than the oH1 detection level.	<ul style="list-style-type: none"> • Measure the ambient temperature. • Increase the airflow in the control panel. • Install a cooling device (cooling fan or air conditioner) to lower the ambient temperature. • Remove objects near the drive that are producing too much heat.
		The load is too heavy.	<ul style="list-style-type: none"> • Measure the output current. • Decrease the load. • Decrease the value set in C6-02 [<i>Carrier Frequency Selection</i>].
oH3	Motor Overheat (PTC Input)	The thermistor wiring that detects motor temperature is defective.	Correct wiring errors.

Code	Name	Causes	Possible Solutions
		<p>A fault occurred on the machine. Example: The machine is locked.</p>	<p>Examine the machine and remove the cause of the fault</p>
		<p>The motor has overheated.</p>	<ul style="list-style-type: none"> • Check the load level, acceleration/ deceleration time, and motor start/stop frequency (cycle time). • Decrease the load. • Increase the values set in <i>C1-01 to C1-08 [Acceleration/Deceleration Times]</i>. • Set <i>E2-01 [Motor Rated Current (FLA)]</i> correctly to the value specified by the motor nameplate. • Make sure that the motor cooling system is operating correctly, and repair or replace it if it is damaged. • Adjust <i>E1-04 to E1-10 [V/f Pattern Parameters]</i>. For motor 2, adjust <i>E3-04 to E3-10</i>. Decrease the values set in <i>E1-08 [Mid Point A Voltage]</i> and <i>E1-10 [Minimum Output Voltage]</i>. <p>Note: If the values set in <i>E1-08</i> and <i>E1-10</i> are too low, the overload tolerance will decrease at low speeds.</p>
oH4	Motor Overheat Fault (PTC Input)	<p>The motor has overheated.</p>	<ul style="list-style-type: none"> • Check the load level, acceleration/ deceleration time, and motor start/stop frequency (cycle time). • Decrease the load. • Increase the values set in <i>C1-01 to C1-08 [Acceleration/Deceleration Times]</i>. • Set <i>E2-01 [Motor Rated Current (FLA)]</i> correctly to the value specified by the motor nameplate. • Make sure that the motor cooling system is operating correctly, and repair or replace it if it is damaged. • Adjust <i>E1-04 to E1-10 [V/f Pattern Parameters]</i>. For motor 2, adjust <i>E3-04 to E3-10</i>. Decrease the values set in <i>E1-08 [Mid Point A Voltage]</i> and <i>E1-10 [Minimum Output Voltage]</i>. <p>Note: If the values set in <i>E1-08</i> and <i>E1-10</i> are too low, the overload tolerance will decrease at low speeds.</p>

Code	Name	Causes	Possible Solutions
oL1	Motor Overload	The load is too large.	Decrease the load. Note: Reset <i>oL1</i> when <i>U4-16 [Motor oL1 Level]</i> < 100.
		The acceleration/deceleration times or cycle times are too short.	<ul style="list-style-type: none"> Examine the acceleration/deceleration times and the motor start/stop frequencies (cycle times). Increase the values set in <i>C1-01 to C1-08 [Acceleration/Deceleration Times]</i>.
		Overload occurred while running at low speed.	<ul style="list-style-type: none"> Decrease the load when running at low speed. Increase the motor speed. If the motor is run frequently at low speeds, replace the motor with a larger motor or use a drive-dedicated motor. Note: For general-purpose motors, overload can occur while running at low speed when operating at below the rated current.
		<i>L1-01 [Motor Overload (oL1) Protection]</i> is set incorrectly.	Set <i>L1-01</i> in as specified by the motor qualities for a drive-dedicated motor.
		The V/f pattern does not fit the motor qualities.	<ul style="list-style-type: none"> Examine the ratios between the V/f pattern frequency and voltage. Decrease the voltage if it is too high compared to the frequency. Adjust <i>E1-04 to E1-10 [V/f Pattern Parameters]</i>. For motor 2, adjust <i>E3-04 to E3-10</i>. Decrease the values set in <i>E1-08 [Mid Point A Voltage]</i> and <i>E1-10 [Minimum Output Voltage]</i>. Note: If the values set in <i>E1-08</i> and <i>E1-10</i> are too low, the overload tolerance will decrease at low speeds.
		<i>E1-06 [Base Frequency]</i> is set incorrectly.	Set <i>E1-06</i> to the rated frequency shown on the motor nameplate.
		One drive is operating more than one motor.	Set <i>L1-01 = 0 [Motor Overload (oL1) Protection = Disabled]</i> , connect thermal overload relay to each motor to prevent damage to the motor.

Code	Name	Causes	Possible Solutions
		The electronic thermal protector qualities and the motor overload properties do not match.	<ul style="list-style-type: none"> Examine the motor qualities and set <i>L1-01 [Motor Overload (oL1) Protection]</i> correctly. Connect a thermal overload relay to the motor.
		The electronic thermal protector is operating at an incorrect level.	Set <i>E2-01 [Motor Rated Current (FLA)]</i> correctly to the value specified by the motor nameplate.
		There is increased motor loss from overexcitation operation.	<ul style="list-style-type: none"> Lower the value set in <i>n3-13 [OverexcitationBraking (OEB) Gain]</i>. Set <i>L3-04 ≠ 4 [Stall Prevention during Decel ≠ Overexcitation/High Flux]</i>. Set <i>n3-23 = 0 [Overexcitation Braking Operation = Disabled]</i>.
		The speed search-related parameters are set incorrectly.	<ul style="list-style-type: none"> Examine the settings for all speed search related parameters. Adjust <i>b3-03 [Speed Search Deceleration Time]</i>. Set <i>b3-24 = 1 [Speed Search Method Selection = Speed Estimation]</i> after Auto-Tuning.
		Phase loss in the input power supply is causing the output current to change.	Make sure that there is no phase loss, and repair problems.
		The motor main circuit cable is too long.	<ul style="list-style-type: none"> Replace the drive with a larger capacity model. Decrease <i>C6-02 [Carrier Frequency]</i>. Or set <i>C6-02 = B</i>.
oL2	Drive Overload	The load is too large.	Decrease the load.
		The acceleration/deceleration times or cycle times are too short.	<ul style="list-style-type: none"> Examine the acceleration/deceleration times and the motor start/stop frequencies (cycle times). Increase the values set in <i>C1-01 to C1-08 [Acceleration/Deceleration Times]</i>.

Code	Name	Causes	Possible Solutions
		The V/f pattern does not fit the motor qualities.	<ul style="list-style-type: none"> Examine the ratios between the V/f pattern frequency and voltage. Decrease the voltage if it is too high compared to the frequency. Adjust <i>E1-04</i> to <i>E1-10</i> [<i>V/f Pattern Parameters</i>]. Decrease the values set in <i>E1-08</i> [<i>Mid Point A Voltage</i>] and <i>E1-10</i> [<i>Minimum Output Voltage</i>]. For motor 2, adjust <i>E3-04</i> to <i>E3-10</i>. <p>Note: If the values set in <i>E1-08</i> and <i>E1-10</i> are too low, the overload tolerance will decrease at low speeds.</p>
		The drive capacity is too small.	Replace the drive with a larger capacity model.
		Overload occurred while running at low speed.	<ul style="list-style-type: none"> Decrease the load when running at low speed. Replace the drive with a larger capacity model. Decrease the value set in <i>C6-02</i> [<i>Carrier Frequency Selection</i>].
		The torque compensation gain is too large.	Decrease the value set in <i>C4-01</i> [<i>Torque Compensation Gain</i>] to make sure that the motor does not stall.
		The speed search-related parameters are set incorrectly.	<ul style="list-style-type: none"> Examine the settings for all speed search-related parameters. Adjust <i>b3-03</i> [<i>Speed Search Deceleration Time</i>]. Set <i>b3-24</i> = 1 [<i>Speed Search Method Selection = Speed Estimation</i>] after Auto-Tuning.
		Phase loss in the input power supply is causing the output current to change.	<ul style="list-style-type: none"> Correct errors with the wiring for main circuit drive input power. Make sure that there is no phase loss, and repair problems.
		Overload occurred during overexcitation deceleration.	<ul style="list-style-type: none"> Decrease the value set in <i>n3-13</i> [<i>OverexcitationBraking (OEB) Gain</i>]. Decrease the value set in <i>n3-21</i> [<i>HSB Current Suppression Level</i>].
oL3	Overtorque Detection 1	A fault occurred on the machine. Example: The machine is locked.	Examine the machine and remove the cause of the fault.
		The parameters are incorrect for the load.	Adjust <i>L6-02</i> [<i>Torque Detection Level 1</i>] and <i>L6-03</i> [<i>Torque Detection Time 1</i>] settings.

Code	Name	Causes	Possible Solutions
oL4	Overtorque Detection 2	A fault occurred on the machine. Example: The machine is locked.	Examine the machine and remove the cause of the fault.
		The parameters are incorrect for the load.	Adjust L6-05 [Torque Detection Level 2] and L6-06 [Torque Detection Time 2] settings.
oL5	Mechanical Weakening Detection 1	The drive detected overtorque as specified by the conditions for mechanical weakening detection set in L6-08 [Mechanical Fatigue Detect Select].	Do a deterioration diagnostic test on the machine side.
oL7	High Slip Braking Overload	The load inertia is too large.	<ul style="list-style-type: none"> Decrease deceleration times in C1-02, C1-04, C1-06, and C1-08 [Deceleration Times] for applications that do not use High Slip Braking. Use a braking resistor to decrease the deceleration time.
		An external force on the load side rotated the motor.	
		Something is preventing deceleration on the load side.	<ul style="list-style-type: none"> Increase the value set in n3-04. Connect a thermal overload relay to the motor, and set n3-04 = 1200 s (maximum value).
		The value set in n3-04 [HSB Overload Time] is too small.	
oPr	Keypad Connection Fault	The keypad is not securely connected to the connector on the drive.	Examine the connection between the keypad and the drive.
		The connection cable between the drive and the keypad is disconnected.	<ul style="list-style-type: none"> Remove the keypad and then reconnect it. Replace the cable if damaged.
oS	Overspeed	There is overshoot.	<ul style="list-style-type: none"> Decrease C5-01 [ASR Proportional Gain 1] and increase C5-02 [ASR Integral Time 1]. Use H6-02 to H6-05 [Pulse Train Input Setting Parameters] to adjust the pulse train gain.
		There is an incorrect number of PG pulses set in the drive.	Set H6-02 [Terminal RP Frequency Scaling] to the pulse train frequency during 100% reference (maximum motor rotation speed).
		The oS detection level is set incorrectly.	Adjust F1-08 [Overspeed Detection Level] and F1-09 [Overspeed Detection Delay Time].

Code	Name	Causes	Possible Solutions
		If the drive detects the fault at start or in the low speed range (10% or less) and $n8-57 = 1$ [<i>HFI Overlap Selection = Enabled</i>] for PM Control methods, the high frequency injection gain is too high.	<ul style="list-style-type: none"> Set $E5-xx$ [<i>IPM Motor Parameters</i>] correctly or do Rotational Auto-Tuning. Decrease the value of $n8-41$ [<i>HFI P Gain</i>] in 0.5 unit increments. <p>Note: Set $n8-41 > 0.0$ for IPM motors.</p>
ov	Overvoltage	The deceleration time is too short and too much regenerative energy is flowing back into the drive.	<ul style="list-style-type: none"> Increase the values set in $C1-02$, $C1-04$, $C1-06$, or $C1-08$ [<i>Deceleration Times</i>]. Connect a dynamic braking option to the drive. Perform Deceleration Rate Tuning.
		The acceleration time is too short.	<ul style="list-style-type: none"> Make sure that sudden drive acceleration does not cause the fault. Increase the values set in $C1-01$, $C1-03$, $C1-05$, or $C1-07$ [<i>Acceleration Times</i>]. Increase the value set in $C2-02$ [<i>S-Curve Time @ End of Accel</i>]. Set $L3-11 = 1$ [<i>Overvoltage Suppression Select = Enabled</i>].
		The braking load is too large.	Connect a dynamic braking option to the drive.
		There are surge voltages in the input power supply.	Connect a DC link choke to the drive. Note: If you turn the phase advancing capacitors ON and OFF and use thyristor converters in the same power supply system, there can be surge voltages that irregularly increase the input voltage.
		The drive output cable or motor is shorted to ground (the current short to ground is charging the main circuit capacitor of the drive through the power supply).	<ol style="list-style-type: none"> Examine the motor main circuit cable, terminals, and motor terminal box, and then remove ground faults. Re-energize the drive.

Code	Name	Causes	Possible Solutions
		The speed search-related parameters are set incorrectly (this fault also occurs during recovery from momentary power loss and after Auto Restarts).	<ul style="list-style-type: none"> Examine the settings for all speed search related parameters. Set $b3-19 \neq 0$ [<i>Speed Search Restart Attempts $\neq 0$ times</i>]. Adjust $b3-03$ [<i>Speed Search Deceleration Time</i>]. Do Stationary Auto-Tuning for Line-to-Line Resistance and then set $b3-24 = 1$ [<i>Speed Search Method Selection = Speed Estimation</i>].
		The power supply voltage is too high.	Decrease the power supply voltage to match the drive rated voltage.
		The braking resistor or braking resistor unit wiring is incorrect.	Correct wiring errors in the connection to the braking resistor or braking resistor unit.
		Electrical interference caused a drive malfunction.	<ul style="list-style-type: none"> Examine the control circuit lines, main circuit lines, and ground wiring, and decrease the effects of electrical interference. Make sure that a magnetic contactor is not the source of the electrical interference, then use a Surge Protective Device if necessary.
		The load inertia is set incorrectly.	<ul style="list-style-type: none"> Examine the load inertia settings with KEB, overvoltage suppression, or stall prevention during deceleration. Adjust $L3-25$ [<i>Load Inertia Ratio</i>] to match the qualities of the machine.
		The Short Circuit Braking function used in OLV/PM control method.	Connect a braking resistor to the drive.
		There is motor hunting.	<ul style="list-style-type: none"> Adjust $n1-02$ [<i>Hunting Prevention Gain Setting</i>]. Adjust $n2-02$ [<i>Automatic Freq Regulator Time 1</i>] and $n2-03$ [<i>Automatic Freq Regulator Time 2</i>]. Adjust $n8-45$ [<i>Speed Feedback Detection Gain</i>] and $n8-47$ [<i>Pull-in Current Comp Filter Time</i>].
		Speed search does not complete at start when you set $A1-02 = 8$ [<i>EZOLV</i>] and use an induction motor.	When $E9-01 = 0$ [<i>Motor Type Selection = Induction (IM)</i>], set $b3-24 = 2$ [<i>Speed Search Method Selection = Current Detection Speed Search</i>].
PE1, PE2	PLC Faults	The communication option detected a fault.	Refer to the manual for the communication option card.

Code	Name	Causes	Possible Solutions
PF	Input Phase Loss	There is a phase loss in the drive input power.	Correct errors with the wiring for main circuit drive input power.
		There is loose wiring in the drive input power terminals.	Tighten the terminal screws to the correct tightening torque.
		The drive input power voltage is changing too much.	<ul style="list-style-type: none"> Examine the input power for problems. Make the drive input power stable. If the input power supply is good, examine the magnetic contactor on the main circuit side for problems.
		There is unsatisfactory balance between voltage phases.	<ul style="list-style-type: none"> Examine the input power for problems. Make the drive input power stable. Set $L8-05 = 0$ [<i>Input Phase Loss Protection Sel = Disabled</i>].
		The main circuit capacitors have become unserviceable.	<ul style="list-style-type: none"> Examine the capacitor maintenance time in monitor $U4-05$ [<i>Capacitor Maintenance</i>]. If $U4-05$ is more than 90%, replace the control board or the drive. For information about replacing the control board, contact Yaskawa or your nearest sales representative. If drive input power is correct and the fault stays, replace the control board or the drive. For information about replacing the control board, contact Yaskawa or your nearest sales representative.
PGo	Encoder (PG) Feedback Loss	The holding brake is stopping the motor.	Release the holding brake.
rF	Braking Resistor Fault	The resistance of the dynamic braking option connected to the drive is too low.	Use a dynamic braking option that fits the model and duty rating of the drive.
		A regenerative converter or regenerative unit is connected to the drive.	Set $L8-55 = 0$ [<i>Internal DB Transistor Protection = Disable</i>].
rH	Braking Resistor Overheat	The deceleration time is too short and excessive regenerative energy is flowing back into the drive.	<ul style="list-style-type: none"> Check the load level, deceleration time, and speed. Decrease the load. Increase the values set in $C1-02$, $C1-04$, $C1-06$, or $C1-08$ [<i>Deceleration Times</i>]. Use a dynamic braking option that lets you use more power.

Code	Name	Causes	Possible Solutions
		The duty cycle is too high.	Examine the duty cycle. Note: When $L8-01 = 1$ [3% ERF DB Resistor Protection = Enabled], the maximum braking duty cycle is 3%.
		The braking load is too heavy.	<ul style="list-style-type: none"> Calculate the braking load and braking power again, and decrease the braking load. Use a braking resistor that improves braking power.
		The braking resistor is not sufficient.	Use the braking resistor specifications to select a sufficient braking resistor.
rr	Dynamic Braking Transistor Fault	The drive control circuit is damaged.	<ul style="list-style-type: none"> Re-energize the drive. If the fault stays, replace the control board or the drive. For information about replacing the control board, contact Yaskawa or your nearest sales representative.
		There is a malfunction in the internal braking transistor of the drive.	
SC	Short Circuit/IGBT Failure	Overheating caused damage to the motor or the motor insulation is not satisfactory.	Measure the motor insulation resistance, and replace the motor if there is electrical conduction or unserviceable insulation.
		The motor main circuit cable is contacting ground to make a short circuit.	<ul style="list-style-type: none"> Examine the motor main circuit cable for damage, and repair short circuits. Measure the resistance between the motor main circuit cable and the ground terminal. If there is electrical conduction, replace the cable.
		A short circuit or ground fault on the drive output side caused damage to the output transistor of the drive.	<ul style="list-style-type: none"> Make sure that there is not a short circuit in terminal B1 and terminals U/T1, V/T2, and W/T3. Make sure that there is not a short circuit in terminals - and terminals U/T1, V/T2, and W/T3. If there is a short circuit, contact Yaskawa or your nearest sales representative.
		When $A1-02 = 5, 6$ [Control Method Selection = OL/PM or AOLV/PM], the output current is more than the value set in $L8-27$ [Overcurrent Detection Gain].	Set $L8-27$ correctly.
SCF	Safety Circuit Fault	The safety circuit is broken.	Replace the control board or the drive. For information about replacing the control board, contact Yaskawa or your nearest sales representative.

Code	Name	Causes	Possible Solutions
SEr	Speed Search Retries Exceeded	The speed search-related parameters are set incorrectly.	<ul style="list-style-type: none"> Decrease <i>b3-10</i> [<i>Speed Estimation Detection Gain</i>]. Increase <i>b3-17</i> [<i>Speed Est Retry Current Level</i>]. Increase <i>b3-18</i> [<i>Speed Est Retry Detection Time</i>]. Do Auto-Tuning again.
		The motor is coasting in the opposite direction of the Run command.	Set <i>b3-14</i> = 1 [<i>Bi-directional Speed Search = Enabled</i>].
STPo	Motor Step-Out Detected	The motor code is set incorrectly for PM Control Methods.	<ul style="list-style-type: none"> Set <i>E5-01</i> [<i>PM Motor Code Selection</i>] correctly as specified by the motor. For specialized motors, refer to the motor test report and set <i>E5-xx</i> correctly.
		The load is too large.	<ul style="list-style-type: none"> Increase the value set in <i>n8-55</i> [<i>Motor to Load Inertia Ratio</i>]. Increase the value set in <i>n8-51</i> [<i>Pull-in Current @ Acceleration</i>]. If the drive detects <i>STPo</i> during deceleration when increasing the value set in <i>n8-51</i>, set the value of <i>n8-79</i> [<i>Pull-in Current @ Deceleration</i>] lower than <i>n8-51</i>. Decrease the load. Replace the drive and motor with larger capacity models.
		The load inertia is too large.	Increase the value set in <i>n8-55</i> .
		The acceleration/deceleration times are too short.	<ul style="list-style-type: none"> Increase the values set in <i>C1-01</i> to <i>C1-08</i> [<i>Acceleration/Deceleration Times</i>]. Increase the value set in <i>C2-01</i> [<i>S-Curve Time @ Start of Accel</i>].
		Speed response is too slow.	Increase the value set in <i>n8-55</i> .
TiM	Keypad Time Not Set	There is a battery in the keypad, but the date and time are not set.	Use the keypad to set the date and time.
UL3	Undertorque Detection 1	A fault occurred on the machine. Example: There is a broken pulley belt.	Examine the machine and remove the cause of the fault.
		The parameters are incorrect for the load.	Adjust <i>L6-02</i> [<i>Torque Detection Level 1</i>] and <i>L6-03</i> [<i>Torque Detection Time 1</i>] settings.

Code	Name	Causes	Possible Solutions
UL4	Undertorque Detection 2	A fault occurred on the machine. Example: There is a broken pulley belt.	Examine the machine and remove the cause of the fault.
		The parameters are incorrect for the load.	Adjust L6-05 [Torque Detection Level 2] and L6-06 [Torque Detection Time 2] settings.
UL5	Mechanical Weakening Detection 2	The drive detected undertorque as specified by the conditions for mechanical weakening detection set in L6-08 [Mechanical Fatigue Detect Select].	Examine the machine for deterioration.
Uv1	DC Bus Undervoltage	There is a phase loss in the drive input power.	Correct errors with the wiring for main circuit drive input power.
		There is loose wiring in the drive input power terminals.	Tighten the terminal screws to the correct tightening torque.
		The drive input power voltage is changing too much.	<ul style="list-style-type: none"> Examine the input power for problems. Make the drive input power stable. If the input power supply is good, examine the magnetic contactor on the main circuit side for problems.
		There was a loss of power.	Use a better power supply.
		The main circuit capacitors have become unserviceable.	Examine the capacitor maintenance time in monitor U4-05 [Capacitor Maintenance]. If U4-05 is more than 90%, replace the control board or the drive. For information about replacing the control board, contact Yaskawa or your nearest sales representative.
		The relay or contactor on the soft-charge bypass relay is damaged.	U4-06 [PreChargeRelayMainte] shows the performance life of the soft-charge bypass relay. If U4-06 is more than 90%, replace the board or the drive. For information about replacing the board, contact Yaskawa or your nearest sales representative.
Uv2	Control Power Undervoltage	The value set in L2-02 [Power Loss Ride Through Time] increased and the momentary power loss recovery unit is not connected to the drive.	Connect the momentary power loss recovery unit to the drive.

Code	Name	Causes	Possible Solutions
		There was a problem with the drive hardware.	<ul style="list-style-type: none"> • Re-energize the drive. • If the fault stays, replace the control board or the drive. For information about replacing the control board, contact Yaskawa or your nearest sales representative.
Uv3	Soft Charge Answerback Fault	The relay or contactor on the soft-charge bypass relay is damaged.	<ul style="list-style-type: none"> • Re-energize the drive. • If the fault stays, replace the control board or the drive. • Check monitor <i>U4-06 [PreChargeRelayMainte]</i> shows the performance life of the soft-charge bypass relay. If <i>U4-06</i> is more than 90%, replace the board or the drive. For information about replacing the control board, contact Yaskawa or your nearest sales representative.

◆ Minor Faults/Alarms

This section gives information about the causes and possible solutions when a minor fault or alarm occurs. Use the information in this table to remove the cause of the minor fault or alarm.

Code	Name	Causes	Possible Solutions
aEr	Station Address Setting Error	The node address for the communication option is not in the permitted setting range.	<ul style="list-style-type: none"> • For CC-Link communication, set <i>F6-10 [CC-Link Node Address]</i> correctly. • For MECHATROLINK communication, set <i>F6-20 [MECHATROLINK Station Address]</i> correctly. • For CANopen communication, set <i>F6-35 [CANopen Node ID Selection]</i> correctly.
bAT	Keypad Battery Low Voltage	The keypad battery voltage is low.	Replace the keypad battery.
bb	Baseblock	An external baseblock command was entered through MFDI terminal S1 to S7, and the drive output stopped as shown by an external baseblock command.	Examine the external sequence and timing of the baseblock command input.

Code	Name	Causes	Possible Solutions
bCE	Bluetooth Communication Error	The smartphone or tablet with DriveWizard Mobile installed is too far from the keypad.	Use the smartphone or tablet 10 m (32.8 ft) or nearer to the keypad. Note: bCE can occur when the smartphone or tablet is 10 m or nearer to the keypad depending on the specifications of the smartphone or tablet.
		Radio waves from a different device are causing interference with the communication between the smartphone or tablet and keypad.	Make sure that no device around the keypad uses the same radio bandwidth (2400 MHz to 2480 MHz), and prevent radio interference.
boL	Braking Transistor Overload	The duty cycle of the braking transistor is high (the regeneration power or repetition frequency is high).	<ul style="list-style-type: none"> • Install a regenerative converter. • Increase the deceleration time.
		You enabled the protective function for the braking transistor when you have a regenerative converter.	Set $L8-55 = 0$ [<i>Internal DB TransistorProtection Selection = Disable</i>].
		The braking transistor in the drive is broken.	Replace the drive.
bUS	Option Communication Error	The communications cable wiring is incorrect.	Correct wiring errors.
		There is a short-circuit in the communications cable or the communications cable is not connected.	<ul style="list-style-type: none"> • Repair short circuits and connect cables. • Replace the defective communications cable.
		Electrical interference caused a communication data error.	<ul style="list-style-type: none"> • Examine the control circuit lines, main circuit lines, and ground wiring, and decrease the effects of electrical interference. • Make sure that a magnetic contactor is not the source of the electrical interference, then use a Surge Protective Device if necessary. • Use only the recommended cables or other shielded line. Ground the shield on the controller side or the drive input power side. • Separate the communication wiring from drive power lines, and install a noise filter to the input side of the power supply for communication. • Decrease the effects of electrical interference from the controller.

Code	Name	Causes	Possible Solutions
		The option card is incorrectly installed to the drive.	Correctly install the option card to the drive.
		The option card is damaged.	If the alarm continues and the wiring is correct, replace the option card.
CALL	Serial Comm Transmission Error	The communications cable wiring is incorrect.	Correct wiring errors.
		There is a short-circuit in the communications cable or the communications cable is not connected.	<ul style="list-style-type: none"> Repair the short-circuited or disconnected portion of the cable. Replace the defective communications cable.
		A programming error occurred on the controller side.	Examine communications at start-up and correct programming errors.
		The communications circuitry is damaged.	<ul style="list-style-type: none"> Do a self-diagnostics check. If the problem continues, replace the control board or the drive. For information about replacing the control board, contact Yaskawa or your nearest sales representative.
		The termination resistor setting for MEMOBUS/Modbus communications is incorrect.	On the last drive in a MEMOBUS/Modbus network, set DIP switch S2 to the ON position to enable the termination resistor.
CE	Modbus Communication Error	The communications cable wiring is incorrect.	Correct wiring errors.
		There is a short-circuit in the communications cable or the communications cable is not connected.	<ul style="list-style-type: none"> Repair short circuits and connect cables. Replace the defective communications cable.
		Electrical interference caused a communication data error.	<ul style="list-style-type: none"> Examine the control circuit lines, main circuit lines, and ground wiring, and decrease the effects of electrical interference. Make sure that a magnetic contactor is not the source of the electrical interference, then use a Surge Protective Device if necessary. Use only the recommended cables or other shielded line. Ground the shield on the controller side or the drive input power side. Separate the communication wiring from drive power lines, and install a noise filter to the input side of the power supply for communication. Decrease the effects of electrical interference from the controller.

Code	Name	Causes	Possible Solutions
		The communication protocol is not compatible.	<ul style="list-style-type: none"> Examine the values set in <i>H5-xx</i>. Examine the settings on the controller side and correct the difference in communication conditions.
		The value set in <i>H5-09 [CE Detection Time]</i> is too small for the communications cycle.	<ul style="list-style-type: none"> Change the controller software settings. Increase the value set in <i>H5-09</i>.
		The controller software or hardware is causing a communication problem.	Examine the controller and remove the cause of the problem.
CP1	Comparator 1 Limit Error	The monitor value set in <i>H2-20 [Comparator 1 Monitor Selection]</i> was in the range of <i>H2-21 [Comparator 1 Lower Limit]</i> and <i>H2-22 [Comparator 1 Upper Limit]</i> .	Examine the monitor value and remove the cause of the fault.
CP2	Comparator 2 Limit Error	The monitor value set in <i>H2-26 [Comparator 2 Monitor Selection]</i> was outside the range of <i>H2-27 [Comparator 2 Lower Limit]</i> and <i>H2-28 [Comparator 2 Upper Limit]</i> .	Examine the monitor value and remove the cause of the fault.
CrST	Cannot Reset	The drive received a fault reset command when a Run command was active.	Turn off the Run command then de-energize and re-energize the drive.
CyC	MECHATROLINK CommCycleSettingErr	The communications cycle setting of the controller is not in the permitted range of the MECHATROLINK interface option.	Set the communications cycle of the controller in the permitted range of the MECHATROLINK interface option.
CyPo	Cycle Power to Accept Changes	Although <i>F6-15 = 1 [Comm. Option Parameters Reload = Reload Now]</i> , the drive does not update the communication option parameters.	Re-energize the drive to update the communication option parameters.
dEv	Speed Deviation	The load is too large.	Decrease the load.
		The acceleration/deceleration times are too short.	Increase the values set in <i>C1-01 to C1-08 [Acceleration/Deceleration Times]</i> .
		The <i>dEv</i> detection level settings are incorrect.	Adjust <i>F1-10 [Speed Deviation Detection Level]</i> and <i>F1-11 [Speed Deviation Detect DelayTime]</i> .
		The load is locked up.	Examine the machine.
		The holding brake is stopping the motor.	Release the holding brake.

Code	Name	Causes	Possible Solutions
dnE	Drive Disabled	A terminal set for $H1-xx = 6A$ [<i>Drive Enable</i>] turned OFF.	Examine the operation sequence.
dWA2	DriveWorksEZ Alarm 2	There was an error in the DriveWorksEZ program.	Examine the DriveWorksEZ program and remove the cause of the fault. This is not a drive fault.
dWA3	DriveWorksEZ Alarm 3	There was an error in the DriveWorksEZ program.	Examine the DriveWorksEZ program and remove the cause of the fault. This is not a drive fault.
dWAL	DriveWorksEZ Alarm	There was an error in the DriveWorksEZ program.	Examine the DriveWorksEZ program and remove the cause of the fault. This is not a drive fault.
E5	MECHATROLINK Watchdog Timer Err	The drive detected a watchdog circuit exception while it received data from the controller.	Examine the MECHATROLINK cable connection. If this error occurs frequently, examine the wiring and decrease the effects of electrical interference as specified by these manuals: <ul style="list-style-type: none"> MECHATROLINK-II Installation Guide (MECHATROLINK Members Association, manual number MMATDEP011) MECHATROLINK-III Installation Manual (MECHATROLINK Members Association, publication number MMATDEP018)
EF	FWD/REV Run Command Input Error	A forward command and a reverse command were input at the same time for longer than 0.5 s.	Examine the forward and reverse command sequence and correct the problem.
EF0	Option Card External Fault	The communication option card received an external fault from the controller.	<ol style="list-style-type: none"> Find the device that caused the external fault and remove the cause. Clear the external fault input from the controller.
		A programming error occurred on the controller side.	Examine the operation of the controller program.
EF1	External Fault (Terminal S1)	MFDI terminal S1 caused an external fault through an external device.	<ol style="list-style-type: none"> Find the device that caused the external fault and remove the cause. Clear the external fault input in the MFDI.
		The wiring is incorrect.	Correctly connect the signal line to MFDI terminal S1.
		<i>External Fault [H1-01 = 2C to 2F]</i> is set to MFDI terminal S1, but the terminal is not in use.	Correctly set the MFDI.

Code	Name	Causes	Possible Solutions
EF2	External Fault (Terminal S2)	MFDI terminal S2 caused an external fault through an external device.	<ol style="list-style-type: none"> 1. Find the device that caused the external fault and remove the cause. 2. Clear the external fault input in the MFDI.
		The wiring is incorrect.	Correctly connect the signal line to MFDI terminal S2.
		<i>External Fault [HI-02 = 2C to 2F] is set to MFDI terminal S2, but the terminal is not in use.</i>	Correctly set the MFDI.
EF3	External Fault (Terminal S3)	MFDI terminal S3 caused an external fault through an external device.	<ol style="list-style-type: none"> 1. Find the device that caused the external fault and remove the cause. 2. Clear the external fault input in the MFDI.
		The wiring is incorrect.	Correctly connect the signal line to MFDI terminal S3.
		<i>External Fault [HI-03 = 2C to 2F] is set to MFDI terminal S3, but the terminal is not in use.</i>	Correctly set the MFDI.
EF4	External Fault (Terminal S4)	MFDI terminal S4 caused an external fault through an external device.	<ol style="list-style-type: none"> 1. Find the device that caused the external fault and remove the cause. 2. Clear the external fault input in the MFDI.
		The wiring is incorrect.	Correctly connect the signal line to MFDI terminal S4.
		<i>External Fault [HI-04 = 2C to 2F] is set to MFDI terminal S4, but the terminal is not in use.</i>	Correctly set the MFDI.
EF5	External Fault (Terminal S5)	MFDI terminal S5 caused an external fault through an external device.	<ol style="list-style-type: none"> 1. Find the device that caused the external fault and remove the cause. 2. Clear the external fault input in the MFDI.
		The wiring is incorrect.	Correctly connect the signal line to MFDI terminal S5.
		<i>External Fault [HI-05 = 2C to 2F] is set to MFDI terminal S5, but the terminal is not in use.</i>	Correctly set the MFDI.
EF6	External Fault (Terminal S6)	MFDI terminal S6 caused an external fault through an external device.	<ol style="list-style-type: none"> 1. Find the device that caused the external fault and remove the cause. 2. Clear the external fault input in the MFDI.
		The wiring is incorrect.	Correctly connect the signal line to MFDI terminal S6.

Code	Name	Causes	Possible Solutions
		<i>External Fault [HI-06 = 2C to 2F]</i> is set to MFDI terminal S6, but the terminal is not in use.	Correctly set the MFDI.
EF7	External Fault (Terminal S7)	MFDI terminal S7 caused an external fault through an external device.	<ol style="list-style-type: none"> Find the device that caused the external fault and remove the cause. Clear the external fault input in the MFDI.
		The wiring is incorrect.	Correctly connect the signal line to MFDI terminal S7.
		<i>External Fault [HI-07 = 2C to 2F]</i> is set to MFDI terminal S7, but the terminal is not in use.	Correctly set the MFDI.
EP24v	External Power 24V Supply	The voltage of the main circuit power supply decreased, and the 24 V power supply is supplying power to the drive.	<ul style="list-style-type: none"> Examine the main circuit power supply. Turn ON the main circuit power supply to run the drive.
FbH	Excessive PID Feedback	The <i>FbH</i> detection level is set incorrectly.	Adjust <i>b5-36 [PID High Feedback Detection Lvl]</i> and <i>b5-37 [PID High Feedback Detection Time]</i> .
		There is a problem with the PID feedback wiring.	Correct errors with the PID control wiring.
		The feedback sensor is not operating correctly.	Examine the sensors on the control device side.
		A fault occurred in the feedback input circuit of the drive.	Replace the board or the drive. For information about replacing the control board, contact Yaskawa or your nearest sales representative.
FbL	PID Feedback Loss	The <i>FbL</i> detection level is set incorrectly.	Adjust <i>b5-13 [PID Feedback Loss Detection Lvl]</i> and <i>b5-14 [PID Feedback Loss Detection Time]</i> .
		There is a problem with the PID feedback wiring.	Correct errors with the PID control wiring.
		The feedback sensor is not operating correctly.	Examine the sensors on the control device side.
		A fault occurred in the feedback input circuit of the drive.	Replace the board or the drive. For information about replacing the control board, contact Yaskawa or your nearest sales representative.
HCA	High Current Alarm	The load is too heavy.	<ul style="list-style-type: none"> Decrease the load for applications with repetitive starts and stops. Replace the drive with a larger capacity model.

Code	Name	Causes	Possible Solutions
		The acceleration time is too short.	<ul style="list-style-type: none"> Calculate the torque necessary during acceleration related to the load inertia and the specified acceleration time. Increase the values set in <i>C1-01</i>, <i>C1-03</i>, <i>C1-05</i>, or <i>C1-07</i> [<i>Acceleration Times</i>] until you get the necessary torque. Increase the values set in <i>C2-01</i> to <i>C2-04</i> [<i>S-Curve Characteristics</i>] until you get the necessary torque. Replace the drive with a larger capacity model.
		The drive is trying to operate a specialized motor or a motor that is larger than the maximum applicable motor output of the drive.	<ul style="list-style-type: none"> Examine the motor nameplate, the motor, and the drive to make sure that the drive rated current is larger than the motor rated current. Replace the drive with a larger capacity model.
		The current level temporarily increased because of speed search after a momentary power loss or while trying to Auto Restart.	If speed search or Auto Restart cause an increase in current, the drive can temporarily show this alarm. The time that the drive shows the alarm is short. No more steps are necessary to clear the alarm.
L24v	Loss of External Power 24 Supply	The voltage of the backup 24 V power supply has decreased. The main circuit power supply is operating correctly.	<ul style="list-style-type: none"> Examine the external 24 V power supply for disconnected wires and wiring errors and repair the problems. Examine the external 24 V power supply for problems.
LoG	Log Com Error	There is not a micro SD in the keypad.	Put a micro SD card in the keypad.
		<ul style="list-style-type: none"> The drive is connected to USB. The number of log communication files is more than 1000. The micro SD card does not have available memory space. The line number data in a log communication file was changed. A communication error between the keypad and drive occurred during a log communication. 	Set <i>o5-01</i> = 0 [<i>Log Start/Stop Selection</i> = OFF].

Code	Name	Causes	Possible Solutions
LT-1	Cooling Fan Maintenance Time	The cooling fan is at 90% of its expected performance life.	<ol style="list-style-type: none"> Use the procedures in this manual to replace the cooling fan. Set $o4-03 = 0$ [Fan Operation Time Setting = 0 h] to reset the cooling fan operation time.
LT-2	Capacitor Maintenance Time	The capacitors for the main circuit and control circuit are at 90% of expected performance life.	Replace the board or the drive. For information about replacing the control board, contact Yaskawa or your nearest sales representative.
LT-3	SoftChargeBypassRelay Maintenance Time	The soft charge bypass relay is at 90% of its expected performance life.	Replace the board or the drive. For information about replacing the control board, contact Yaskawa or your nearest sales representative.
LT-4	IGBT Maintenance Time (50%)	The IGBT is at 50% of its expected performance life.	Check the load, carrier frequency, and output frequency.
oH	Heatsink Overheat	The ambient temperature is high and the heatsink temperature is more than the <i>L8-02 [Overheat Alarm Level]</i> .	<ul style="list-style-type: none"> Measure the ambient temperature. Increase the airflow around the drive. Install a cooling device (cooling fan or air conditioner) to lower the ambient temperature. Remove objects near the drive that are producing too much heat.
		There is not sufficient airflow around the drive.	<ul style="list-style-type: none"> Give the drive the correct installation space as shown in the manual. Make sure that there is sufficient circulation around the control panel. Examine the drive for dust or other unwanted materials that could clog the cooling fan. Remove unwanted materials that prevent air circulation.
		The internal cooling fan or fans have stopped.	<ol style="list-style-type: none"> Use the procedures in this manual to replace the cooling fan. Set $o4-03 = 0$ [Fan Operation Time Setting = 0 h].
oH2	External Overheat (H1-XX=B)	An external device sent an <i>oH2</i> .	<ol style="list-style-type: none"> Find the external device that output the overheat alarm. Remove the cause of the problem. Clear the <i>Overheat Alarm (oH2) [H1-xx = B]</i> set to MFDI terminals S1 to S7.
oH3	Motor Overheat (PTC Input)	The thermistor wiring that detects motor temperature is defective.	Correct wiring errors.

Code	Name	Causes	Possible Solutions
		A fault occurred on the machine. Example: The machine is locked.	Examine the machine and remove the cause of the fault
		The motor has overheated.	<ul style="list-style-type: none"> • Check the load level, acceleration/ deceleration time, and motor start/stop frequency (cycle time). • Decrease the load. • Increase the values set in <i>C1-01 to C1-08 [Acceleration/Deceleration Times]</i>. • Set <i>E2-01 [Motor Rated Current (FLA)]</i> correctly to the value specified by the motor nameplate. • Make sure that the motor cooling system is operating correctly, and repair or replace it if it is damaged. • Adjust <i>E1-04 to E1-10 [V/f Pattern Parameters]</i>. For motor 2, adjust <i>E3-04 to E3-10</i>. Decrease the values set in <i>E1-08 [Mid Point A Voltage]</i> and <i>E1-10 [Minimum Output Voltage]</i>. <p>Note: If the values set in <i>E1-08</i> and <i>E1-10</i> are too low, the overload tolerance will decrease at low speeds.</p>
oL3	Overtorque 1	A fault occurred on the machine. Example: The machine is locked.	Examine the machine and remove the cause of the fault
		The parameters are incorrect for the load.	Adjust <i>L6-02 [Torque Detection Level 1]</i> and <i>L6-03 [Torque Detection Time 1]</i> .
oL4	Overtorque 2	A fault occurred on the machine. Example: The machine is locked.	Examine the machine and remove the cause of the fault
		The parameters are incorrect for the load.	Adjust <i>L6-05 [Torque Detection Level 2]</i> and <i>L6-06 [Torque Detection Time 2]</i> .
oL5	Mechanical Weakening Detection 1	The drive detected overtorque as specified by the conditions for mechanical weakening detection set in <i>L6-08 [Mechanical Fatigue Detect Select]</i> .	Do a deterioration diagnostic test on the machine side.

Code	Name	Causes	Possible Solutions
oS	Overspeed	There is overshoot.	<ul style="list-style-type: none"> Decrease C5-01 [ASR Proportional Gain 1] and increase C5-02 [ASR Integral Time 1]. Adjust the pulse train gain with H6-02 to H6-05 [Pulse Train Input Setting Parameters].
		There is an incorrect number of PG pulses set in the drive.	Set H6-02 [Terminal RP Frequency Scaling] to the pulse train frequency during 100% reference (maximum motor rotation speed).
		The oS detection level is set incorrectly.	Adjust F1-08 [Overspeed Detection Level] and F1-09 [Overspeed Detection Delay Time].
ov	Overvoltage	There are surge voltages in the input power supply.	Connect a DC link choke to the drive. Note: If you turn the phase advancing capacitors ON and OFF and use thyristor converters in the same power supply system, there can be surge voltages that irregularly increase the input voltage.
		The drive output cable or motor is shorted to ground (the current short to ground is charging the main circuit capacitor of the drive through the power supply).	<ol style="list-style-type: none"> Examine the motor main circuit cable, terminals, and motor terminal box, and then remove ground faults. Re-energize the drive.
		The power supply voltage is too high.	Decrease the power supply voltage to match the drive rated voltage.
		Electrical interference caused a drive malfunction.	<ul style="list-style-type: none"> Examine the control circuit lines, main circuit lines, and ground wiring, and decrease the effects of electrical interference. Make sure that a magnetic contactor is not the source of the electrical interference, then use a Surge Protective Device if necessary. Set L5-01 $\neq 0$ [Number of Auto-Restart Attempts $\neq 0$ times].
PASS	Modbus Communication Test	The MEMOBUS/Modbus communications test is complete.	The PASS display will turn off after communications test mode is cleared.
PF	Input Phase Loss	There is a phase loss in the drive input power.	Correct all wiring errors with the main circuit power supply.
		Loose wiring in the input power terminals.	Tighten the screws to the correct tightening torque.

Code	Name	Causes	Possible Solutions
		The drive input power voltage is changing too much.	<ul style="list-style-type: none"> Examine the supply voltage for problems. Make the drive input power stable.
		Unsatisfactory balance between voltage phases.	<ul style="list-style-type: none"> Examine the supply voltage for problems. Make the drive input power stable. If the supply voltage is good, examine the magnetic contactor on the main circuit side for problems.
		The main circuit capacitors have become unserviceable.	<ul style="list-style-type: none"> Examine the capacitor maintenance time in monitor <i>U4-05 [CapacitorMaintenance]</i>. If <i>U4-05</i> is more than 90%, replace the capacitor. Contact Yaskawa or your nearest sales representative for more information.
			<ul style="list-style-type: none"> Examine the supply voltage for problems. Re-energize the drive. If the alarm stays, replace the circuit board or the drive. For information about replacing the control board, contact Yaskawa or your nearest sales representative.
rUn	Motor Switch during Run	The drive received a <i>Motor 2 Selection [H1-xx = 16]</i> during run.	Make sure that the drive receives the Motor 2 Selection while the drive is stopped.
SE	Modbus Test Mode Error	MEMOBUS/Modbus communications self-diagnostics [<i>H1-xx = 67</i>] was done while the drive was running.	Stop the drive and do MEMOBUS/Modbus communications self-diagnostics.
SToF	Safe Torque OFF Hardware	One of the two terminals H1-HC and H2-HC received the Safe Disable input signal.	<ul style="list-style-type: none"> Make sure that the Safe Disable signal is input from an external source to terminals H1-HC or H2-HC.
		The Safe Disable input signal is wired incorrectly.	<ul style="list-style-type: none"> When the Safe Disable function is not in use, use a jumper to connect terminals H1-HC and H2-HC.
		There is internal damage to one Safe Disable channel.	Replace the board or the drive. For information about replacing the control board, contact Yaskawa or your nearest sales representative.
TiM	Keypad Time Not Set	There is a battery in the keypad, but the date and time are not set.	Set the date and time with the keypad.

Code	Name	Causes	Possible Solutions
TrPC	IGBT Maintenance Time (90%)	The IGBT is at 90% of its expected performance life.	Replace the IGBT or the drive. For information about replacing the control board, contact Yaskawa or your nearest sales representative.
UL3	Undertorque Detection 1	A fault occurred on the machine. Example: There is a broken pulley belt.	Examine the machine and remove the cause of the fault
		The parameters are incorrect for the load.	Adjust L6-02 [Torque Detection Level 1] and L6-03 [Torque Detection Time 1].
UL4	Undertorque Detection 2	A fault occurred on the machine. Example: There is a broken pulley belt.	Examine the machine and remove the cause of the fault
		The parameters are incorrect for the load.	Adjust L6-05 [Torque Detection Level 2] and L6-06 [Torque Detection Time 2].
UL5	Mechanical Weakening Detection 2	The drive detected undertorque as specified by the conditions for mechanical weakening detection set in L6-08 [Mechanical Fatigue Detect Select].	Examine the machine for deterioration.
Uv	DC Bus Undervoltage	The drive input power voltage is changing too much.	<ul style="list-style-type: none"> • Use a better power supply voltage to align with the drive rated voltage. • Make the drive input power stable. • If there is not a fault with the input power supply, examine the magnetic contactor on the main circuit side for faults.
		A phase loss occurred in the drive input power.	Correct errors with the wiring for main circuit drive input power.
		There is loose wiring in the drive input power terminals.	Examine for loose screws and tighten them as specified by the tightening torque values in the manual.
		There was a loss of power.	Use a better power supply.
		The main circuit capacitors have deteriorated.	Examine the capacitor maintenance time in monitor U4-05 [Capacitor Maintenance]. If U4-05 is more than 90%, replace the control board or the drive. For information about replacing the control board, contact Yaskawa or your nearest sales representative.

Code	Name	Causes	Possible Solutions
		The drive input power transformer is too small and voltage drops when the power is switched on.	<ul style="list-style-type: none"> Check for an alarm when a molded-case circuit breaker, Leakage Breaker (ELCB, GFCI, or RCM/RCD) (with overcurrent protective function), or magnetic contactor is ON. Check the capacity of the drive power supply transformer.
		Air inside the drive is too hot.	Measure the ambient temperature of the drive.
		The Charge LED is broken.	Replace the board or the drive. For information about replacing the control board, contact Yaskawa or your nearest sales representative.

◆ Parameter Setting Errors

Parameter setting errors occur when multiple parameter settings do not agree, or when parameter setting values are not correct. Refer to the table in this section, examine the parameter setting that caused the error, and remove the cause of the error. You must first correct the parameter setting errors before you can operate the drive. The drive will not send notification signals for the faults and alarms when these parameter setting errors occur.

Code	Name	Causes	Possible Solutions
oPE01	Drive Capacity Setting Error	The value set in <i>o2-04 [Drive Model (KVA) Selection]</i> does not agree with the drive model.	Set <i>o2-04</i> to the correct value.
oPE02	Parameter Range Setting Error	Parameter settings are not in the applicable setting range.	<ol style="list-style-type: none"> Push  to show <i>U1-18 [oPE Fault Parameter]</i>, and find parameters that are not in the applicable setting range. Correct the parameter settings. <p>Note:</p> <ul style="list-style-type: none"> If more than one error occurs at the same time, other <i>oPE</i> errors have priority over <i>oPE02</i>.
		Set <i>E2-01</i> \leq <i>E2-03</i> [<i>Motor Rated Current (FLA) \leq Motor No-Load Current</i>].	<p>Make sure that <i>E2-01</i> $>$ <i>E2-03</i>.</p> <p>Note:</p> <p>If it is necessary to set <i>E2-01</i> $<$ <i>E2-03</i>, first lower the value set in <i>E2-03</i>, and then set <i>E2-01</i>.</p>

Code	Name	Causes	Possible Solutions
oPE03	Multi-Function Input Setting Err	<p>The settings for these parameters do not agree:</p> <ul style="list-style-type: none"> • <i>H1-01 to H1-07 [Terminals S1 to S8 Function Selection]</i> • <i>H7-01 to H7-04 [Virtual Multi-Function Inputs 1 to 4]</i> 	Correct the parameter settings.
		<p>The settings for MFDIs overlap.</p> <p>Note: This does not include <i>H1-xx = 20 to 2F [MFDI Function Select = External Fault]</i> and <i>[Reserved]</i>.</p>	Set the parameters correctly to prevent MFDI function overlap.
		<p>You did not set these pairs of MFDI functions to Digital Inputs (<i>H1-xx</i> and <i>H7-01 to H7-04</i>) at the same time:</p> <ul style="list-style-type: none"> • Setting values <i>10 [Up Command]</i> and <i>11 [Down Command]</i> • Setting values <i>75 [Up 2 Command]</i> and <i>76 [Down 2 Command]</i> • Setting values <i>42 [Run Command (2-Wire Sequence 2)]</i> and <i>43 [FWD/REV (2-Wire Sequence 2)]</i> 	Set the MFDI pairs.
		<p>You set a minimum of two of these MFDI combinations to Digital Inputs (<i>H1-xx</i> and <i>H7-01 to H7-04</i>) at the same time:</p> <ul style="list-style-type: none"> • Setting values <i>10 [Up Command]</i> and <i>11 [Down Command]</i> • Setting values <i>75 [Up 2 Command]</i> and <i>76 [Down 2 Command]</i> • Setting value <i>A [Accel/Decel Ramp Hold]</i> • Setting value <i>1E [Reference Sample Hold]</i> • Setting values <i>44 to 46 [Add Offset Frequency 1 to 3 (d7-01 to d7-03)]</i> 	Remove the function settings that are not in use.

Code	Name	Causes	Possible Solutions
		<p>You set these commands in Digital Inputs (<i>H1-xx</i> and <i>H7-01</i> to <i>H7-04</i>) at the same time:</p> <ul style="list-style-type: none"> • Setting values 61 [<i>Speed Search from Fmax</i>] and 62 [<i>Speed Search from Fref</i>] • Setting values 65, 66, 7A, 7B [<i>KEB Ride-Thru 1 or 2 Activate</i>] and 68 [<i>High Slip Braking (HSB) Activate</i>] • Setting values 16 [<i>Motor 2 Selection</i>] and 1A [<i>Accel/Decel Time Selection 2</i>] • Setting values 65, 66 [<i>KEB Ride-Thru 1 Activate</i>] and 7A, 7B [<i>KEB Ride-Thru 2 Activate</i>] • Setting values 40, 41 [<i>Forward RUN (2-Wire), Reverse RUN (2-Wire)</i>] and 42, 43 [<i>Run Command (2-Wire Sequence 2), FWD/REV (2-Wire Sequence 2)</i>] • Setting values 60 [<i>DC Injection Braking Command</i>] and 6A [<i>Drive Enable</i>] • Setting values 16 [<i>Motor 2 Selection</i>] and 75, 76 [<i>Up 2 Command, Down 2 Command</i>] 	<p>Remove the function settings that are not in use.</p>
		<p>Settings for N.C. and N.O. input [<i>H1-xx</i>] for these functions were selected at the same time:</p> <ul style="list-style-type: none"> • Setting value 15 [<i>Fast Stop (N.O.)</i>] • Setting value 17 [<i>Fast Stop (N.C.)</i>] 	<p>Remove one of the function settings.</p>
		<p>You entered these settings while <i>H1-xx = 2</i> [<i>External Reference 1/2 Selection</i>]:</p> <ul style="list-style-type: none"> • <i>b1-15 = 4</i> [<i>Frequency Reference Selection 2 = Pulse Train Input</i>] • <i>H6-01 ≠ 0</i> [<i>Terminal RP Pulse Train Function ≠ Frequency Reference</i>] 	<p>Set <i>H6-01 = 0</i>.</p>

Code	Name	Causes	Possible Solutions
		<p>You entered these settings while $H1-xx = 2$ [External Reference 1/2 Selection]:</p> <ul style="list-style-type: none"> $b1-15 = 3$ [Option PCB] or $b1-16 = 3$ [Run Command Selection 2 = Option PCB] You did not connect an option to the drive. 	Connect an input option to the drive.
		<p>You entered these settings while $H1-xx = 2$ [External Reference 1/2 Selection]:</p> <ul style="list-style-type: none"> $b1-15 = 1$ [Analog Input] $H3-02 \neq 0$ [Terminal A1 Function Selection \neq Frequency Reference] or $H3-10 \neq 0$ [Terminal A2 Function Selection \neq Frequency Reference] 	Set $H3-02 = 0$ or $H3-10 = 0$.
		<p>These parameters are set at the same time:</p> <ul style="list-style-type: none"> $H1-xx \neq 6A$ [Drive Enable] $H2-xx = 38$ [Drive Enabled] 	Correct the parameter settings.
		<p>These parameters are set at the same time:</p> <ul style="list-style-type: none"> $H6-01 \neq 3$ [PG Speed Feedback (V/F Control)] $H1-xx = 7E$ [Reverse Rotation Identifier] 	Correct the parameter settings.
		<p>These parameters are set at the same time:</p> <ul style="list-style-type: none"> $H1-xx = 75/76$ [Up 2 /Down 2 Command] $H3-01, H3-09 = 1$ [Terminal A1, A2 Signal Level Select = 0 to +10V(Without Limit)] 	Remove one of the function settings.
oPE05	Run Cmd/Freq Ref Source Sel Err	The setting to assign the Run command or frequency reference to an option card or the pulse train input is incorrect.	Correct the parameter settings.

Code	Name	Causes	Possible Solutions
		<p><i>b1-01 = 3 [Frequency Reference Selection 1 = Option PCB] is set, but there is no option card connected to the drive.</i></p> <p><i>b1-02 = 3 [Run Command Selection 1 = Option PCB] is set, but there is no option card connected to the drive.</i></p>	<p>Connect an option card to the drive.</p>
		<p>These parameters are set at the same time:</p> <ul style="list-style-type: none"> • <i>b1-01 = 4 [Pulse Train Input]</i> • <i>H6-01 ≠ 0 [Terminal RP Pulse Train Function ≠ Frequency Reference]</i> 	<p>Set <i>H6-01 = 0</i>.</p>
oPE07	Analog Input Selection Error	<p>The settings for <i>H3-02 and H3-10 [MFAI Function Select]</i> and <i>H7-30 [Virtual Analog Input Selection]</i> overlap.</p>	<p>Set <i>H3-02, H3-10, and H7-30</i> correctly to prevent overlap.</p> <p>Note:</p> <p>It is possible to set these functions to multiple analog input terminals at the same time:</p> <ul style="list-style-type: none"> • Setting value <i>0 [Frequency Reference]</i> • Setting values <i>F and 1F [Not Used]</i>

Code	Name	Causes	Possible Solutions
		<p>These parameters are set at the same time:</p> <ul style="list-style-type: none"> • $H3-02, H3-10, H7-30 = B$ [PID Feedback] • $H6-01 = 1$ [Terminal RP Pulse Train Function = PID Feedback Value] <p>These parameters are set at the same time:</p> <ul style="list-style-type: none"> • $H3-02, H3-10, H7-30 = C$ [PID Setpoint] • $H6-01 = 2$ [PID Setpoint Value] <p>These parameters are set at the same time:</p> <ul style="list-style-type: none"> • $H3-02, H3-10, H7-30 = C$ • $b5-18 = 1$ [PID Setpoint Selection = Enabled] <p>These parameters are set at the same time:</p> <ul style="list-style-type: none"> • $H6-01 = 2$ • $b5-18 = 1$ 	Remove the function settings that are not in use.
oPE08	Parameter Selection Error	<p>A function was set that is not compatible with the control method selected in $A1-02$ [Control Method Selection].</p> <p>When $A1-02 = 2$ [OLV], you used these parameter settings:</p> <ul style="list-style-type: none"> • $n2-02 > n2-03$ [Automatic Freq Regulator Time 1 > Automatic Freq Regulator Time 2] • $C4-02 > C4-06$ [Torque Compensation Delay Time > Motor 2 Torque Comp Delay Time] 	<ol style="list-style-type: none"> 1. Push ENTER Key to show $U1-18$ [oPE Fault Parameter], and find parameters that are not in the applicable setting range. 2. Correct the parameter settings. <p>Note: If more than one error occurs at the same time, other oPExx errors have priority over oPE02.</p> <ul style="list-style-type: none"> • Set $n2-02 < n2-03$. • Set $C4-02 < C4-06$.

Code	Name	Causes	Possible Solutions
		When $A1-02 = 0$ [V/f], you used these parameter settings: <ul style="list-style-type: none"> • H6-01 = 3 [Terminal RP Pulse Train Function = Speed Feedback (V/F Control)] • H1-xx = 16 [MFDI Function Select = Motor 2 Selection] 	Correct the parameter settings. Note: You cannot use Speed Feedback (V/F Control) with the Motor Switch function.
		When $A1-02 = 5$ [OLV/PM], you set E5-02 to E5-07 [PM Motor Parameters] = 0.	<ul style="list-style-type: none"> • Set E5-01 [PM Motor Code Selection] correctly as specified by the motor. • For specialized motors, refer to the motor test report and set E5-xx correctly.
		When $A1-02 = 5, 6$ [OLV/PM, AOLV/PM], you used these parameter settings: <ul style="list-style-type: none"> • E5-09 = 0.0 [PM Back-EMF V_{peak} (mV/(rad/s)) = 0.0 mV/(rad/s)] • E5-24 = 0.0 [PM Back-EMF L-L V_{rms} (mV/rpm) = 0.0 mV/min⁻¹] 	Set E5-09 or E5-24 to the correct value.
		When $A1-02 = 5, 6$, you set E5-09 $\neq 0$ and E5-24 $\neq 0$.	Set E5-09 = 0 or E5-24 = 0.
		When $A1-02 = 6$, you set these parameters: <ul style="list-style-type: none"> • n8-57 = 0 [HFI Overlap Selection = Disabled] • You set E1-09 [Minimum Output Frequency] < the 5% value of E1-06. 	Correct the parameter settings.
		When $A1-02 = 6$, you set these parameters: <ul style="list-style-type: none"> • n8-35 = 0 [Initial Pole Detection Method = Pull-in] • n8-57 = 1 [Enabled] 	Correct the parameter settings.
		When $A1-02 = 8$ [EZOLV], you used these parameter settings: <ul style="list-style-type: none"> • E9-01 = 1, 2 [Motor Type Selection = Permanent Magnet (PM), Synchronous Reluctance (SynRM)] • b3-24 = 2 [Speed Search Method Selection = Current Detection 2] 	When E9-01 = 1 or 2, set b3-24 = 1 [Speed Estimation].

Code	Name	Causes	Possible Solutions
oPE09	PID Control Selection Fault	<p>These parameters are set at the same time:</p> <ul style="list-style-type: none"> $b5-15 \neq 0.0$ [PID Sleep Function Start Level $\neq 0.0$ Hz] $b1-03 = 2, 3$ [Stopping Method Selection = DC Injection Braking to Stop, Coast to Stop with Timer] 	<ul style="list-style-type: none"> Set $b5-15 \neq 0.0$. Set $b1-03 = 0, 1$ [Ramp to Stop, Coast to Stop].
		<p>These parameters are set at the same time:</p> <ul style="list-style-type: none"> $b5-01 = 1, 2$ [Enabled (Standard), Enabled (D = Feedforward)] $d2-02 \neq 0.0$ [Frequency Reference Lower Limit $\neq 0.0\%$] 	Correct the parameter settings.
		<p>These parameters are set at the same time:</p> <ul style="list-style-type: none"> $b5-01 = 1, 2$ [Enabled (Standard), Enabled (D = Feedforward)] $b5-11 = 1$ [PID Output Reverse Selection = Negative Output Accepted] 	Correct the parameter settings.
		<p>These parameters are set at the same time:</p> <ul style="list-style-type: none"> $b5-01 = 3, 4$ [Trim (Fref +PID Out, D = Fdbk), Trim (Fref+PID Out, D = FeedFwd)] $d2-02 \neq 0.0$ has been set. 	Correct the parameter settings.
oPE10	V/f Data Setting Error	<p>The parameters that set the V/f pattern do not satisfy these conditions:</p> <ul style="list-style-type: none"> For motor 1: $E1-09 \leq E1-07 < E1-06 \leq E1-11 \leq E1-04$ [Minimum Output Frequency \leq Mid Point A Frequency $<$ Base Frequency \leq Mid Point B Frequency \leq Maximum Output Frequency] For motor 2: $E3-09 \leq E3-07 < E3-06 \leq E3-11 \leq E3-04$ [Minimum Output Frequency \leq Mid Point A Frequency $<$ Base Frequency \leq Mid Point B Frequency \leq Maximum Output Frequency] 	Set the parameters correctly to satisfy the conditions.

Code	Name	Causes	Possible Solutions
oPE11	Carrier Frequency Setting Error	<p>These parameters are set at the same time:</p> <ul style="list-style-type: none"> • $C6-05 > 6$ [<i>Carrier Freq Proportional Gain</i> > 6] • $C6-04 > C6-03$ [<i>Carrier Frequency Lower Limit</i> > <i>Carrier Frequency Upper Limit</i>] <p>Note: When $C6-05 < 7$, $C6-04$ becomes disabled. The drive sets the carrier frequency to the value set to $C6-03$.</p>	Set $C6-02$ to $C6-05$ correctly.
		$C6-02$ to $C6-05$ settings are not in the applicable setting range.	
oPE13	Pulse Monitor Selection Error	$H6-06 = 101, 102, 105, \text{ or } 116$ [<i>Terminal MP Monitor Selection = Frequency Reference, Output Frequency, Motor Speed, Output Frequency after Soft Starter</i>] has not been set when $H6-07 = 0$ [<i>Terminal MP Frequency Scaling = 0 Hz</i>].	Set $H6-06$ correctly.
oPE16	Energy Saving Constants Error	The Energy Saving parameters are not set in the applicable setting range.	Make sure that $E5-xx$ is set correctly as specified by the motor nameplate data.

Code	Name	Causes	Possible Solutions
oPE33	Digital Output Selection Error	<p>These two parameters are set at the same time:</p> <ul style="list-style-type: none"> $H2-60 \neq F$ [Term MA,MB, MC Secondary Function \neq Not Used] $H2-01 = 1xx$ [Term MA,MB, MC Function Selection = Inverse output of xx] 	<p>Clear the H2-01 to H2-03 = 1xx [Inverse output of xx] settings.</p> <p>Note:</p> <p>If you use the function to output logical calculation results (H2-60, H2-63, H2-66 \neq F), you cannot set H2-01 to H2-03 = 1xx.</p>
		<p>These two parameters are set at the same time:</p> <ul style="list-style-type: none"> $H2-63 \neq F$ [Terminal P1 Secondary Function \neq Not Used] $H2-02 = 1xx$ [Term P1 Function Selection = Inverse output of xx] 	
		<p>These two parameters are set at the same time:</p> <ul style="list-style-type: none"> $H2-66 \neq F$ [Terminal P2 Secondary Function \neq Not Used] $H2-03 = 1xx$ [Term P2 Function Selection = Inverse output of xx] 	
		<p>These parameter pairs are set incorrectly:</p> <ul style="list-style-type: none"> $H2-21$ [Comparator 1 Lower Limit] $>$ $H2-22$ [Comparator 1 Upper Limit] $H2-27$ [Comparator 2 Lower Limit] $>$ $H2-28$ [Comparator 2 Upper Limit] 	<ul style="list-style-type: none"> Set parameters $H2-21 \leq H2-22$. Set parameters $H2-27 \leq H2-28$.

◆ Auto-Tuning Errors

This table gives information about errors detected during Auto-Tuning. If the drive detects an Auto-Tuning error, the keypad will show the error and the motor will coast to stop. The drive will not send notification signals for faults and alarms when Auto-Tuning errors occur.

Two types of Auto-Tuning errors are: *Endx* and *Erx*. *Endx* identifies that Auto-Tuning has successfully completed with calculation errors. Find and repair the cause of the error and do Auto-Tuning again, or set the motor parameters manually. You can use the drive in the application if you cannot find the cause of the *Endx* error.

Erx identifies that Auto-Tuning was not successful. Find and repair the cause of the error and do Auto-Tuning again.

Code	Name	Causes	Possible Solutions
End1	Excessive Rated Voltage Setting	The torque reference was more than 20% during Auto-Tuning or the no-load current that was measured after Auto-Tuning is more than 80%.	<ul style="list-style-type: none"> • Make sure that the input motor nameplate data is correct. • Do Auto-Tuning again and correctly set the motor nameplate data. • If you can uncouple the motor and load, remove the motor from the machine and do Rotational Auto-Tuning again. • If you cannot uncouple the motor and load, use the results from Auto-Tuning.
End2	Iron Core Saturation Coefficient	The motor nameplate data entered during Auto-Tuning is incorrect.	<ul style="list-style-type: none"> • Make sure that the input motor nameplate data is correct. • Do Auto-Tuning again and correctly set the motor nameplate data.
		Auto-Tuning results were not in the applicable parameter setting range, and <i>E2-07</i> or <i>E2-08</i> [<i>Motor Saturation Coefficient 2</i>] have temporary values.	<ul style="list-style-type: none"> • Examine and repair damaged motor wiring. • If you can uncouple the motor and load, remove the motor from the machine and do Rotational Auto-Tuning again.
End3	Rated Current Setting Alarm	The rated current value is incorrect.	Do Auto-Tuning again and set the correct rated current shown on the motor nameplate.
End4	Adjusted Slip Calculation Error	The Auto-Tuning results were not in the applicable parameter setting range.	<ul style="list-style-type: none"> • Make sure the input motor nameplate data is correct. • Do Rotational Auto-Tuning again and correctly set the motor nameplate data. • If you cannot uncouple the motor and load, do Stationary Auto-Tuning 2.
		The motor rated slip that was measured after Stationary Auto-Tuning was 0.2 Hz or lower.	
		The motor rated slip that was measured after compensation with <i>E2-08</i> [<i>Motor Saturation Coefficient 2</i>] is not in the applicable range.	
		The secondary resistor measurement results were not in the applicable range.	
End5	Resistance Tuning Error	The Auto-Tuning results of the Line-to-Line Resistance were not in the applicable range.	<ul style="list-style-type: none"> • Make sure that the input motor nameplate data is correct. • Examine and repair damaged motor wiring.
End6	Leakage Inductance Alarm	The Auto-Tuning results were not in the applicable parameter setting range.	Make sure that the input motor nameplate data is correct, and do Auto-Tuning again.

Code	Name	Causes	Possible Solutions
		<i>A1-02 [Control Method Selection]</i> setting is not applicable.	<ul style="list-style-type: none"> Examine the value set in <i>A1-02</i>. Make sure that the input motor nameplate data is correct, and do Auto-Tuning again.
End7	No-Load Current Alarm	The Auto-Tuning results of the motor no-load current value were not in the applicable range.	Examine and repair damaged motor wiring.
		Auto-Tuning results were less than 5% of the motor rated current.	Make sure that the input motor nameplate data is correct, and do Auto-Tuning again.
End8	HFI Alarm	<ul style="list-style-type: none"> Inductance saliency ratio (<i>E5-07/E5-06</i>) is too small. The drive cannot find the <i>n8-36 [HF1 Frequency Level for L Tuning]</i> value. 	<ul style="list-style-type: none"> Set the correct value on the motor nameplate <i>E5-xx [PM motor parameters]</i> or do Stationary/ Rotational Auto-Tuning, and then do High Frequency Injection Tuning again. When it is necessary to set <i>n8-35 = 1 [Initial Pole Detection Method = High Frequency Injection]</i> or <i>n8-57 = 1 [HF1 Overlap Selection = Enabled]</i>, make sure that there is no unusual noise in the low speed range (10% or less) and that the motor does not rotate in reverse at start. If there is unusual noise in the low speed range (10% or less), increase <i>n8-41</i> in increments of 0.5. Set <i>n8-41 > 0.0</i> for IPM motors. <p>Note: If the drive detects <i>End8</i>, it will automatically set <i>n8-35 = 0 [Pull-in]</i> and <i>n8-57 = 0 [Disabled]</i>. Do not change the settings unless necessary.</p>

Code	Name	Causes	Possible Solutions
End9	Initial Pole Detection Alarm	The drive cannot calculate the correct value for <i>n8-84 [Polarity Detection Current]</i> during High Frequency Injection Tuning.	<ul style="list-style-type: none"> Set the correct value on the motor nameplate <i>E5-xx [PM motor parameters]</i> or do Stationary/ Rotational Auto-Tuning, and then do High Frequency Injection Tuning again. When <i>n8-35 = 1 [Initial Pole Detection Method = High Frequency Injection]</i> or <i>n8-57 = 1 [HFI Overlap Selection = Enabled]</i>, make sure that the motor does not rotate in reverse at start. <p>If there is unusual noise in the low speed range (10% or less), increase <i>n8-41</i> in increments of 0.5. Set <i>n8-41 > 0.0</i> for IPM motors.</p> <p>Note: If the drive detects <i>End9</i>, it will automatically set <i>n8-35 = 0 [Pull-in]</i> and <i>n8-57 = 0 [Disabled]</i>. Do not change the settings unless necessary.</p>
Er-01	Motor Data Error	The motor nameplate data entered during Auto-Tuning is incorrect.	<ul style="list-style-type: none"> Make sure that the motor nameplate data is correct. Do Auto-Tuning again and correctly set the motor nameplate data.
		The combination of the motor rated power and motor rated current do not match.	<ul style="list-style-type: none"> Examine the combination of drive capacity and motor output. Do Auto-Tuning again, and correctly set the motor rated power and motor rated current.
		The combination of the motor rated current that was entered during Auto-Tuning and <i>E2-03 [Motor No-Load Current]</i> do not match.	<ul style="list-style-type: none"> Examine the motor rated current and the no-load current. Set <i>E2-03</i> correctly. Do Auto-Tuning again, and correctly set the motor rated current.
		The combination of the setting values of Motor Base Frequency and Motor Base Speed do not match.	Do Auto-Tuning again, and correctly set the Motor Base Frequency and Motor Base Speed.
Er-02	Drive in an Alarm State	The motor nameplate data entered during Auto-Tuning is incorrect.	<ul style="list-style-type: none"> Make sure that the motor nameplate data entered in Auto-Tuning is correct. Do Auto-Tuning again and correctly set the motor nameplate data.
		You did Auto-Tuning while the drive had a minor fault or alarm.	Clear the minor fault or alarm and do Auto-Tuning again.

Code	Name	Causes	Possible Solutions
		There is a defective motor cable or cable connection.	Examine and repair motor wiring.
		The load is too large.	<ul style="list-style-type: none"> Decrease the load. Examine the machine area to see if, for example, the motor shaft is locked.
		The drive detected a minor fault during Auto-Tuning.	<ol style="list-style-type: none"> Stop Auto-Tuning. Examine the minor fault code and remove the cause of the problem. Do Auto-Tuning again.
Er-03	STOP Button was Pressed	During Auto-Tuning,  was pushed.	Auto-Tuning did not complete correctly. Do Auto-Tuning again.
Er-04	Line-to-Line Resistance Error	The Auto-Tuning results were not in the applicable parameter setting range.	<ul style="list-style-type: none"> Examine and repair motor wiring. Disconnect the machine from the motor and do Rotational Auto-Tuning again.
		Auto-Tuning did not complete in a pre-set length of time.	
		There is a defective motor cable or cable connection.	<ul style="list-style-type: none"> Make sure that the input motor nameplate data is correct. Do Auto-Tuning again and correctly set the motor nameplate data.
		The motor nameplate data entered during Auto-Tuning is incorrect.	
Er-05	No-Load Current Error	The Auto-Tuning results were not in the applicable parameter setting range.	<ul style="list-style-type: none"> Examine and repair motor wiring. Disconnect the machine from the motor and do Rotational Auto-Tuning again.
		Auto-Tuning did not complete in a pre-set length of time.	
		The motor nameplate data entered during Auto-Tuning is incorrect.	<ul style="list-style-type: none"> Make sure that the input motor nameplate data is correct. Do Auto-Tuning again and correctly set the motor nameplate data.
		Rotational Auto-Tuning was done with a load that was more than 30% of the rating connected to the motor.	<ul style="list-style-type: none"> Disconnect the machine from the motor and do Rotational Auto-Tuning again. If you cannot uncouple the motor and load, make sure that the load is less than 30% of the motor rating. If a mechanical brake is installed in the motor, release the brake during Rotational Auto-Tuning.

Code	Name	Causes	Possible Solutions
Er-08	Rated Slip Error	The motor nameplate data entered during Auto-Tuning is incorrect.	<ul style="list-style-type: none"> Make sure that the input motor nameplate data is correct. Do Auto-Tuning again and correctly set the motor nameplate data.
		Auto-Tuning did not complete in a pre-set length of time.	<ul style="list-style-type: none"> Examine and repair the motor wiring. If the motor and machine are connected during Rotational Auto-Tuning, decouple the motor from the machinery.
		The Auto-Tuning results were not in the applicable parameter setting range.	
		Rotational Auto-Tuning was done with a load that was more than 30% of the rating connected to the motor.	<ul style="list-style-type: none"> Disconnect the machine from the motor and do Rotational Auto-Tuning again. If you cannot uncouple the motor and load, make sure that the load is less than 30% of the motor rating. If a mechanical brake is installed in the motor, release the brake during Rotational Auto-Tuning.
Er-09	Acceleration Error	The motor did not accelerate for the specified acceleration time.	<ol style="list-style-type: none"> Increase the value set in <i>CI-01 [Acceleration Time 1]</i>. Disconnect the machine from the motor and do Rotational Auto-Tuning again.
		The value of <i>L7-01</i> or <i>L7-02 [Forward/Reverse Torque Limit]</i> is small.	Increase the value set in <i>L7-01</i> or <i>L7-02</i> .
		Rotational Auto-Tuning was done with a load that was more than 30% of the rating connected to the motor.	<ul style="list-style-type: none"> Disconnect the machine from the motor and do Rotational Auto-Tuning again. If you cannot uncouple the motor and load, make sure that the load is less than 30% of the motor rating. If a mechanical brake is installed in the motor, release the brake during Rotational Auto-Tuning.
Er-10	Motor Direction Error	There is defective drive and motor wiring.	Examine and repair motor wiring.
		There is defective drive and encoder wiring.	Examine and repair the wiring to the encoder.
		The machine pulled the motor to rotate in the opposite direction.	Disconnect the machine from the motor and do Rotational Auto-Tuning again.
		When the torque reference is 100% or higher, the sign of the speed reference was opposite of the detected speed.	

Code	Name	Causes	Possible Solutions
Er-11	Motor Speed Error	The torque reference during acceleration is too high (100%).	<ul style="list-style-type: none"> • Increase the value set in <i>C1-01 [Acceleration Time 1]</i>. • Disconnect the machine from the motor and do Rotational Auto-Tuning again.
Er-12	Current Detection Error	There is a phase loss in the drive input power. (U/T1, V/T2, W/T3)	Examine and repair motor wiring.
		The current exceeded the current rating of the drive.	<ul style="list-style-type: none"> • Check the motor wiring for any short circuits between the wires.
		The output current is too low.	<ul style="list-style-type: none"> • Check and turn ON any magnetic contactors used between motors. • Replace the control board or the drive. For information about replacing the control board, contact Yaskawa or your nearest sales representative.
		You tried Auto-Tuning without a motor connected to the drive.	Connect the motor and do Auto-Tuning.
		There was a current detection signal error.	Replace the control board or the drive. For information about replacing the control board, contact Yaskawa or your nearest sales representative.
Er-13	Leakage Inductance Alarm	The motor rated current value is incorrect.	Correctly set the rated current indicated on the motor nameplate and perform Auto-Tuning again.
		The drive could not complete tuning for leakage inductance in fewer than 300 seconds.	Examine and repair motor wiring.
Er-14	Motor Speed Error 2	The motor speed was more than two times the amplitude of speed reference during Inertia Tuning.	Decrease the value set in <i>C5-01 [ASR Proportional Gain 1]</i> .
Er-15	Torque Saturation Error	During Inertia Tuning, the output torque was more than the value set in <i>L7-01 to L7-04 [Torque Limit]</i> .	<ul style="list-style-type: none"> • Increase the value set in <i>L7-01 to L7-04 [Torque Limit]</i> as much as possible. • Decrease the values set for the frequency and amplitude of the test signals used when doing inertia tuning. First, decrease the test signal amplitude, and then do Inertia Tuning. If the error continues, decrease the test signal frequency and do Inertia Tuning again.

Code	Name	Causes	Possible Solutions
Er-16	Inertia ID Error	The inertia found by the drive was too small or too large during Inertia Tuning (10% or less, or 50000% or more).	<ul style="list-style-type: none"> Decrease the values set for the frequency and amplitude of the test signals used when doing inertia tuning. First, decrease the test signal amplitude, and then do Inertia Tuning. If the error continues, decrease the test signal frequency and do Inertia Tuning again. Correctly set the motor inertia as specified by the motor, and do Inertia Tuning again.
Er-17	Reverse Prohibited Error	$b1-04 = 1$ [Reverse Operation Selection = Reverse Disabled] Note: You cannot do Inertia Tuning if the drive cannot rotate the motor in reverse.	<ol style="list-style-type: none"> Enable reverse in the target machine. Set $b1-04 = 0$ [Reverse Enabled]. Do Inertia Tuning again.
Er-18	Back EMF Error	The result of the induced voltage tuning was not in the applicable range.	<ol style="list-style-type: none"> Make sure that the input motor nameplate data is correct. Do Auto-Tuning again and correctly set the motor nameplate data.
Er-19	PM Inductance Error	The Auto-Tuning results of the PM motor inductance were not in the applicable range.	<ol style="list-style-type: none"> Make sure that the input motor nameplate data is correct. Do Auto-Tuning again and correctly set the motor nameplate data.
Er-20	Stator Resistance Error	The Auto-Tuning results of the PM Motor Stator Resistance were not in the applicable range.	<ol style="list-style-type: none"> Make sure that the input motor nameplate data is correct. Do Auto-Tuning again and correctly set the motor nameplate data.
Er-25	HighFreq Inject Param Tuning Err	The motor data is incorrect.	Do Stationary Auto-Tuning again. Note: If the drive detects <i>Er-25</i> after doing Stationary Auto-Tuning, the motor may not be able to use high frequency injection control. Contact Yaskawa or your nearest sales representative for more information.

◆ Backup Function Operating Mode Display and Errors

■ Operating Mode Display

When you use the LCD keypad to do the backup function, the keypad shows the running operation on the LCD display. These indicators do not show that an error has occurred.

Keypad Display	Name	Display	Status
Drive and Keypad mismatch. Should the parameters be restored?	Detection of inconsistency between the drive and keypad	Normally displayed	The drive detected the connection of a keypad from a different drive. Select [Yes] to copy parameters backed up in the keypad to the connected drive.
Restore Restore from keypad	Restoring parameters	Flashing	The parameters stored in the keypad have been restored to the drive.
End	Backup/restore/verify operation ended normally	Normally displayed	The parameter backup, restore, or verify operation ended normally.
Backup Backup from Drive	Backing up parameters	Flashing	The parameters stored in the drive are being backed up to the keypad.
Verify Keypad & Drive	Verifying parameters	Flashing	The parameter settings stored in the keypad and the parameter settings in the drive match or are being compared.

■ Backup Function Runtime Errors

When an error occurs, the keypad shows a code to identify the error.

The table in this section show the error codes. If there are errors, refer to these tables:

Note:

Push any key on the keypad to clear an error.

Code	Name	Causes	Possible Solutions
CPEr	Control Mode Mismatch	The keypad setting and drive setting for <i>A1-02</i> [Control Method Selection] do not agree.	<ol style="list-style-type: none"> 1. Set <i>A1-02</i> on the drive to the same value that is on the keypad. 2. Restore the parameters.
CPyE	Error Writing Data	Parameter restore did not end correctly.	Restore the parameters.
CSEr	Control Mode Mismatch	The keypad is broken.	Replace the keypad.
dFPS	Drive Model Mismatch	You tried to restore parameters to a different drive model than the one that you backed up.	<ol style="list-style-type: none"> 1. Examine the drive model that you used to back up the parameters. 2. Restore the parameters.
iFEr	Keypad Communication Error	There was a communications error between the keypad and the drive.	Examine the connector or cable connection.

Code	Name	Causes	Possible Solutions
ndAT	Error Received Data	The parameter settings for model and specifications (power supply voltage and capacity) are different between the keypad and the drive.	<ol style="list-style-type: none"> 1. Make sure that drive model and the value set in <i>o2-04 [Drive Model (KVA) Selection]</i> agree. 2. Restore the parameters.
		The parameters are not stored in the keypad.	<ol style="list-style-type: none"> 1. Connect a keypad that has the correct parameters. 2. Restore the parameters.
PWEr	DWEZ Password Mismatch	The password set in the backup operation with <i>qx-xx [DriveWorksEZ Parameters]</i> and <i>rx-xx [DriveWorksEZ Connections]</i> is incorrect.	Set the DWEZ PC software password supplied by Yaskawa for the DWEZ program user ID downloaded to the drive.
rdEr	Error Reading Data	You tried to back up the data when <i>o3-02 = 0 [Copy Allowed Selection = Disabled]</i> .	Set <i>o3-02 = 1 [Enabled]</i> and back up again.
vAEr	Voltage Class, Capacity Mismatch	The power supply specifications or drive capacity parameter settings are different between the keypad and the drive.	<ol style="list-style-type: none"> 1. Make sure that drive model and the value set in <i>o2-04 [Drive Model (KVA) Selection]</i> agree. 2. Restore the parameters.
vFyE	Parameters do not Match	The parameters that are backed up in the keypad and the parameters in the drive are not the same.	<ol style="list-style-type: none"> 1. Restore or backup the parameter again. 2. Verify the parameters.

16 European Standards



Figure 16.1 CE Mark

The CE Mark identifies that the product meets environmental and safety standards in the European Union. Products manufactured, sold, or imported in the European Union must display the CE Mark.

European Union standards include standards for electrical appliances (Low Voltage Directive), standards for electrical noise (EMC Directive), and standards for machinery (Machinery Directive).

This product displays the CE Mark in accordance with the Low Voltage Directive, the EMC Directive, and the Machinery Directive.

Table 16.1 Harmonized Standards

European Directive	Harmonized Standard
CE Low Voltage Directive Compliance 2014/35/EU	EN 61800-5-1:2007
EMC Directive 2014/30/EU	EN 61800-3:2004/A1:2012
Machinery Directive 2006/42/EC	<ul style="list-style-type: none"> • EN ISO 13849-1:2015 (PL e (Cat.III)) • EN 62061:2005/A2:2015 (SILCL3) • EN 61800-5-2:2007

The customer must display the CE Mark on the final device containing this product. Customers must verify that the final device complies with EU standards.

◆ EU Declaration of Conformity

Go to www.yaskawa.com and search for “EU Declaration of Conformity” to get an original copy of the EU Declaration of Conformity.

Yaskawa declares that this product complies with the following directives and standards at our sole responsibility.

◆ CE Low Voltage Directive Compliance

It has been confirmed that this product complies with the CE Low Voltage Directive by conducting a test according to EN 61800-5-1:2007.

The following conditions must be satisfied for machines and devices incorporating this product to comply with the CE Low Voltage Directive.

■ Area of Use

Install this product in a location with Overvoltage Category III and pollution degree 2 or less as specified in IEC/CE 60664.

■ Guarding Against Debris

When you install IP20/UL Open type drives, use an enclosure that does not let unwanted material enter the drive from above or below.

■ Electrical Installation

Refer to [Figure 16.2](#) for an example of a drive that is wired to comply with the CE Low Voltage Directive.

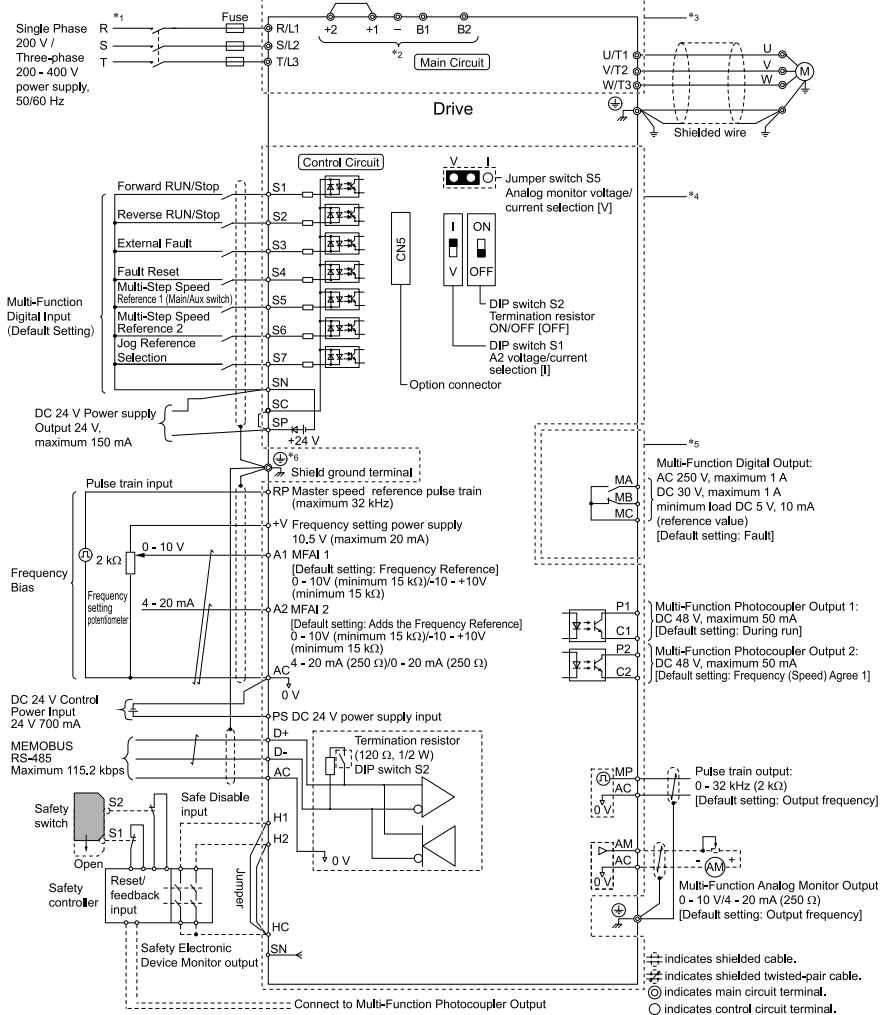

Figure 16.2 Wiring Diagram for CE Low Voltage Directive Compliance

*1 Set L8-05 = 1 [Output Phase Loss Protect Select = Enabled] or set the wiring sequence to prevent input phase loss.

- *2 Use terminals B1, B2, -, +1, and +2 to connect options to the drive.

▲ WARNING *Fire Hazard. Only connect factory-recommended devices or circuits to drive terminals B1, B2, -, +1, and +2. Do not connect an AC power supply lines to these terminals. Incorrect wiring can cause damage to the drive and serious injury or death from fire.*

- *3 For circuit protection, the main circuit is separated from the surface case that can touch the main circuit.
 *4 The control circuit is a Safety Extra-Low Voltage circuit. Separate this circuit from other circuits with reinforced insulation. Make sure that the Safety Extra-Low Voltage circuit is connected as specified.
 *5 Reinforced insulation separates the output terminals from other circuits. Users can also connect circuits that are not Safety Extra-Low Voltage circuits if the drive output is 250 Vac 1 A maximum or 30 Vdc 1 A maximum.
 *6 **▲ WARNING** *Electrical Shock Hazard. Do not ground the shield of the control wiring to the protective ground terminal. It does not comply with technical standards and local codes and can cause serious injury or death.*

■ Main Circuit Wire Gauges and Tightening Torques

▲ WARNING *Electrical Shock Hazard. Only connect factory-recommended devices or circuits to drive terminals B1, B2, -, +1, and +2. Do not connect AC power to these terminals. Incorrect wiring can cause damage to the drive and serious injury or death from fire.*

Note:

- The recommended wire gauges are based on drive continuous current ratings with 75 °C (167 °F) 600 V class 2 heat-resistant indoor PVC wire. Assume these conditions:
 - Ambient temperature: 40 °C (104 °F) maximum
 - Wiring distance: 100 m (3281 ft) maximum
 - Normal Duty rated current value
- Refer to the instruction manual for each device for recommended wire gauges to connect peripheral devices or options to terminals +1, +2, -, B1, and B2. Contact Yaskawa or your nearest sales representative if the recommended wire gauges for the peripheral devices or options are out of the range of the applicable gauges for the drive.

Wire Selection Precautions

Think about line voltage drop before selecting wire gauges. Select wire gauges that drop the voltage by 2% or less of the rated voltage. Increase the wire gauge and the cable length when the risk of voltage drops increases. Calculate line voltage drop with this formula:

Line voltage drop (V) = $\sqrt{3} \times \text{wire resistance } (\Omega/\text{km}) \times \text{wiring distance (m)} \times \text{motor rated current (A)} \times 10^{-3}$.

Precautions during Wiring



- Refer to “Yaskawa AC Drive Option Braking Unit, Braking Resistor Unit Instruction Manual (TOBPC72060001)” for information about wire gauges and tightening torques to connect braking resistor units.
- Use terminals +1 and - to connect a regenerative converter or regenerative unit.

▲ WARNING *Fire Hazard. Do not connect a braking resistor to terminals +1 or -. Use terminals B1 and B2 for the braking resistor connections. If you connect a braking resistor to the incorrect terminals, it can cause damage to the drive and braking circuit and serious injury or death.*













Screw Shape



















These tables use icons in [Table 16.2](#) to show the shapes of the screw heads.







Table 16.2 Icons to Identify Screw Shapes

Icon	Screw Shape
	Phillips/slot combo (+/-)
	Slotted (-)
	Hex socket cap (WAF: 5 mm)

Single-Phase 200 V Class



















Model	Terminal	Recomm. Gauge mm ²	Applicable Gauge mm ²	Wire Stripping Length *7 mm	Terminal Screw Size and Shape	Tightening Torque N·m (lbf·in)
B001	L/L1, N/L2	2.5	2.5	6.5	M3 	0.5 - 0.6 (4.4 - 5.3)
	U/T1, V/T2, W/T3	2.5	2.5	6.5	M3 	0.5 - 0.6 (4.4 - 5.3)
	-, +1	2.5	2.5	6.5	M3 	0.5 - 0.6 (4.4 - 5.3)
	B1, B2	2.5	2.5	6.5	M3 	0.5 - 0.6 (4.4 - 5.3)
		2.5	2.5	-	M3.5 	0.8 - 1.0 (7.1 - 8.9)
B002	L/L1, N/L2	2.5	2.5	6.5	M3 	0.5 - 0.6 (4.4 - 5.3)
	U/T1, V/T2, W/T3	2.5	2.5	6.5	M3 	0.5 - 0.6 (4.4 - 5.3)
	-, +1	2.5	2.5	6.5	M3 	0.5 - 0.6 (4.4 - 5.3)
	B1, B2	2.5	2.5	6.5	M3 	0.5 - 0.6 (4.4 - 5.3)
		2.5	2.5	-	M3.5 	0.8 - 1.0 (7.1 - 8.9)

Model	Terminal	Recomm. Gauge mm ²	Applicable Gauge mm ²	Wire Stripping Length mm	Terminal Screw Size and Shape	Tightening Torque N·m (lbf·in)
B004	L/L1, N/L2	2.5	2.5	6.5	M3 	0.5 - 0.6 (4.4 - 5.3)
	U/T1, V/T2, W/T3	2.5	2.5	6.5	M3 	0.5 - 0.6 (4.4 - 5.3)
	-, +1	2.5	2.5	6.5	M3 	0.5 - 0.6 (4.4 - 5.3)
	B1, B2	2.5	2.5	6.5	M3 	0.5 - 0.6 (4.4 - 5.3)
		2.5	2.5	-	M3.5 	0.8 - 1.0 (7.1 - 8.9)
B006	L/L1, N/L2	2.5	2.5 - 4	8	M3 	0.5 - 0.6 (4.4 - 5.3)
	U/T1, V/T2, W/T3	2.5	2.5 - 4	8	M3 	0.5 - 0.6 (4.4 - 5.3)
	-, +1	2.5	2.5 - 4	8	M3 	0.5 - 0.6 (4.4 - 5.3)
	B1, B2	2.5	2.5 - 4	8	M3 	0.5 - 0.6 (4.4 - 5.3)
		2.5	2.5 - 6	-	M4 	1.2 - 1.5 (10.6 - 13.3)
B010	L/L1, N/L2	2.5	2.5 - 4	8	M3 	0.5 - 0.6 (4.4 - 5.3)
	U/T1, V/T2, W/T3	2.5	2.5 - 4	8	M3 	0.5 - 0.6 (4.4 - 5.3)
	-, +1	2.5	2.5 - 4	8	M3 	0.5 - 0.6 (4.4 - 5.3)
	B1, B2	2.5	2.5 - 4	8	M3 	0.5 - 0.6 (4.4 - 5.3)
		2.5	2.5 - 6	-	M4 	1.2 - 1.5 (10.6 - 13.3)

Model	Terminal	Recomm. Gauge mm ²	Applicable Gauge mm ²	Wire Stripping Length ^{*1} mm	Terminal Screw Size and Shape	Tightening Torque N-m (lbf-in)
B012	L/L1, N/L2	4	2.5 - 6	10	M4 	1.5 - 1.7 (13.5 - 15)
	U/T1, V/T2, W/T3	2.5	2.5 - 4	10	M4 	1.5 - 1.7 (13.5 - 15)
	-, +1	4	2.5 - 6	10	M4 	1.5 - 1.7 (13.5 - 15)
	B1, B2	2.5	2.5 - 4	10	M4 	1.5 - 1.7 (13.5 - 15)
		4	2.5 - 6	-	M4 	1.2 - 1.5 (10.6 - 13.3)













*1 Remove insulation from the ends of wires to expose the length of wire shown.

Three-Phase 200 V Class

Model	Terminal	Recomm. Gauge mm ²	Applicable Gauge mm ²	Wire Stripping Length *1 mm	Terminal Screw Size and Shape	Tightening Torque N·m (lbf·in)
2001	R/L1, S/L2, T/L3	2.5	2.5	6.5	M3 	0.5 - 0.6 (4.4 - 5.3)
	U/T1, V/T2, W/T3	2.5	2.5	6.5	M3 	0.5 - 0.6 (4.4 - 5.3)
	-, +1, +2	2.5	2.5	6.5	M3 	0.5 - 0.6 (4.4 - 5.3)
	B1, B2	2.5	2.5	6.5	M3 	0.5 - 0.6 (4.4 - 5.3)
		2.5	2.5	-	M3.5 	0.8 - 1.0 (7.1 - 8.9)
2002	R/L1, S/L2, T/L3	2.5	2.5	6.5	M3 	0.5 - 0.6 (4.4 - 5.3)
	U/T1, V/T2, W/T3	2.5	2.5	6.5	M3 	0.5 - 0.6 (4.4 - 5.3)
	-, +1, +2	2.5	2.5	6.5	M3 	0.5 - 0.6 (4.4 - 5.3)
	B1, B2	2.5	2.5	6.5	M3 	0.5 - 0.6 (4.4 - 5.3)
		2.5	2.5	-	M3.5 	0.8 - 1.0 (7.1 - 8.9)
2004	R/L1, S/L2, T/L3	2.5	2.5	6.5	M3 	0.5 - 0.6 (4.4 - 5.3)
	U/T1, V/T2, W/T3	2.5	2.5	6.5	M3 	0.5 - 0.6 (4.4 - 5.3)
	-, +1, +2	2.5	2.5	6.5	M3 	0.5 - 0.6 (4.4 - 5.3)
	B1, B2	2.5	2.5	6.5	M3 	0.5 - 0.6 (4.4 - 5.3)
		2.5	2.5	-	M3.5 	0.8 - 1.0 (7.1 - 8.9)



















Model	Terminal	Recomm. Gauge mm ²	Applicable Gauge mm ²	Wire Stripping Length ^{*)} mm	Terminal Screw Size and Shape	Tightening Torque N·m (lbf·in)
2006	R/L1, S/L2, T/L3	2.5	2.5	6.5	M3 ⊖	0.5 - 0.6 (4.4 - 5.3)
	U/T1, V/T2, W/T3	2.5	2.5	6.5	M3 ⊖	0.5 - 0.6 (4.4 - 5.3)
	-, +1, +2	2.5	2.5	6.5	M3 ⊖	0.5 - 0.6 (4.4 - 5.3)
	B1, B2	2.5	2.5	6.5	M3 ⊖	0.5 - 0.6 (4.4 - 5.3)
	⊕	2.5	2.5	-	M3.5 ⊕	0.8 - 1.0 (7.1 - 8.9)
2010	R/L1, S/L2, T/L3	2.5	2.5 - 4	8	M3 ⊖	0.5 - 0.6 (4.4 - 5.3)
	U/T1, V/T2, W/T3	2.5	2.5 - 4	8	M3 ⊖	0.5 - 0.6 (4.4 - 5.3)
	-, +1, +2	2.5	2.5 - 4	8	M3 ⊖	0.5 - 0.6 (4.4 - 5.3)
	B1, B2	2.5	2.5 - 4	8	M3 ⊖	0.5 - 0.6 (4.4 - 5.3)
	⊕	4	2.5 - 6	-	M4 ⊕	1.2 - 1.5 (10.6 - 13.3)
2012	R/L1, S/L2, T/L3	2.5	2.5 - 4	8	M3 ⊖	0.5 - 0.6 (4.4 - 5.3)
	U/T1, V/T2, W/T3	2.5	2.5 - 4	8	M3 ⊖	0.5 - 0.6 (4.4 - 5.3)
	-, +1, +2	2.5	2.5 - 4	8	M3 ⊖	0.5 - 0.6 (4.4 - 5.3)
	B1, B2	2.5	2.5 - 4	8	M3 ⊖	0.5 - 0.6 (4.4 - 5.3)
	⊕	4	2.5 - 6	-	M4 ⊕	1.2 - 1.5 (10.6 - 13.3)

Model	Terminal	Recomm. Gauge mm ²	Applicable Gauge mm ²	Wire Stripping Length mm	Terminal Screw Size and Shape	Tightening Torque N·m (lbf·in)
2021	R/L1, S/L2, T/L3	4	2.5 - 6	10	M4 ⊖	1.5 - 1.7 (13.5 - 15)
	U/T1, V/T2, W/T3	2.5	2.5 - 4	10	M4 ⊖	1.5 - 1.7 (13.5 - 15)
	-, +1, +2	6	4 - 10	10	M4 ⊖	1.5 - 1.7 (13.5 - 15)
	B1, B2	2.5	2.5 - 4	10	M4 ⊖	1.5 - 1.7 (13.5 - 15)
	⊕	6	2.5 - 6	-	M4 ⊕	1.2 - 1.5 (10.6 - 13.3)
2030	R/L1, S/L2, T/L3	6	4 - 10	10	M4 ⊖	1.5 - 1.7 (13.5 - 15)
	U/T1, V/T2, W/T3	6	4 - 10	10	M4 ⊖	1.5 - 1.7 (13.5 - 15)
	-, +1, +2	10	2.5 - 16	10	M4 ⊖	1.5 - 1.7 (13.5 - 15)
	B1, B2	2.5	2.5 - 4	10	M4 ⊖	1.5 - 1.7 (13.5 - 15)
	⊕	6	6 - 16	-	M5 ⊕	2.0 - 2.5 (17.7 - 22.1)
2042	R/L1, S/L2, T/L3	10	2.5 - 16	10	M4 ⊖	1.5 - 1.7 (13.5 - 15)
	U/T1, V/T2, W/T3	10	2.5 - 16	10	M4 ⊖	1.5 - 1.7 (13.5 - 15)
	-, +1, +2	16	4 - 25	18	M5 ⊖	2.3 - 2.5 (19.8 - 22)
	B1, B2	4	2.5 - 6	10	M4 ⊖	1.5 - 1.7 (13.5 - 15)
	⊕	10	6 - 16	-	M5 ⊕	2.0 - 2.5 (17.7 - 22.1)

Model	Terminal	Recomm. Gauge mm ²	Applicable Gauge mm ²	Wire Stripping Length *1 mm	Terminal Screw Size and Shape	Tightening Torque N-m (lbf-in)
2056	R/L1, S/L2, T/L3	16	4 - 25	18	M5 	2.3 - 2.5 (19.8 - 22)
	U/T1, V/T2, W/T3	16	4 - 25	18	M5 	2.3 - 2.5 (19.8 - 22)
	-, +1, +2	25	6 - 35	18	M5 	<ul style="list-style-type: none"> • $\leq 25 \text{ mm}^2$ 2.3 - 2.5 (19.8 - 22) • $35 \text{ mm}^2 \leq$ 4.1 - 4.5 (36 - 40)
	B1, B2	10	4 - 16	10	M4 	1.5 - 1.7 (13.5 - 15)
		10	10 - 25	-	M6 	5.4 - 6.0 (47.8 - 53.1)
2070	R/L1, S/L2, T/L3	25	6 - 35	20	M6 	5 - 5.5 (45 - 49)
	U/T1, V/T2, W/T3	16	6 - 25	20	M6 	5 - 5.5 (45 - 49)
	-, +1, +2	35	10 - 50	20	M6 	5 - 5.5 (45 - 49)
	B1, B2	10	4 - 16	10	M4 	1.5 - 1.7 (13.5 - 15)
		16	10 - 25	-	M6 	5.4 - 6.0 (47.8 - 53.1)

*1 Remove insulation from the ends of wires to expose the length of wire shown.

Three-Phase 400 V Class

Model	Terminal	Recomm. Gauge mm ²	Applicable Gauge mm ²	Wire Stripping Length *1 mm	Terminal Screw Size and Shape	Tightening Torque N·m (lbf·in)
4001	R/L1, S/L2, T/L3	2.5	2.5 - 4	8	M3 	0.5 - 0.6 (4.4 - 5.3)
	U/T1, V/T2, W/T3	2.5	2.5 - 4	8	M3 	0.5 - 0.6 (4.4 - 5.3)
	-, +1, +2	2.5	2.5 - 4	8	M3 	0.5 - 0.6 (4.4 - 5.3)
	B1, B2	2.5	2.5 - 4	8	M3 	0.5 - 0.6 (4.4 - 5.3)
		2.5	2.5 - 6	-	M4 	1.2 - 1.5 (10.6 - 13.3)
4002	R/L1, S/L2, T/L3	2.5	2.5 - 4	8	M3 	0.5 - 0.6 (4.4 - 5.3)
	U/T1, V/T2, W/T3	2.5	2.5 - 4	8	M3 	0.5 - 0.6 (4.4 - 5.3)
	-, +1, +2	2.5	2.5 - 4	8	M3 	0.5 - 0.6 (4.4 - 5.3)
	B1, B2	2.5	2.5 - 4	8	M3 	0.5 - 0.6 (4.4 - 5.3)
		2.5	2.5 - 6	-	M4 	1.2 - 1.5 (10.6 - 13.3)
4004	R/L1, S/L2, T/L3	2.5	2.5 - 4	8	M3 	0.5 - 0.6 (4.4 - 5.3)
	U/T1, V/T2, W/T3	2.5	2.5 - 4	8	M3 	0.5 - 0.6 (4.4 - 5.3)
	-, +1, +2	2.5	2.5 - 4	8	M3 	0.5 - 0.6 (4.4 - 5.3)
	B1, B2	2.5	2.5 - 4	8	M3 	0.5 - 0.6 (4.4 - 5.3)
		4	2.5 - 6	-	M4 	1.2 - 1.5 (10.6 - 13.3)

Model	Terminal	Recomm. Gauge mm ²	Applicable Gauge mm ²	Wire Stripping Length ^{*)} mm	Terminal Screw Size and Shape	Tightening Torque N·m (lbf·in)
4005	R/L1, S/L2, T/L3	2.5	2.5 - 4	8	M3 ⊖	0.5 - 0.6 (4.4 - 5.3)
	U/T1, V/T2, W/T3	2.5	2.5 - 4	8	M3 ⊖	0.5 - 0.6 (4.4 - 5.3)
	-, +1, +2	2.5	2.5 - 4	8	M3 ⊖	0.5 - 0.6 (4.4 - 5.3)
	B1, B2	2.5	2.5 - 4	8	M3 ⊖	0.5 - 0.6 (4.4 - 5.3)
	⊕	4	2.5 - 6	-	M4 ⊕	1.2 - 1.5 (10.6 - 13.3)
4007	R/L1, S/L2, T/L3	2.5	2.5 - 4	8	M3 ⊖	0.5 - 0.6 (4.4 - 5.3)
	U/T1, V/T2, W/T3	2.5	2.5 - 4	8	M3 ⊖	0.5 - 0.6 (4.4 - 5.3)
	-, +1, +2	2.5	2.5 - 4	8	M3 ⊖	0.5 - 0.6 (4.4 - 5.3)
	B1, B2	2.5	2.5 - 4	8	M3 ⊖	0.5 - 0.6 (4.4 - 5.3)
	⊕	4	2.5 - 6	-	M4 ⊕	1.2 - 1.5 (10.6 - 13.3)
4009	R/L1, S/L2, T/L3	2.5	2.5 - 4	8	M3 ⊖	0.5 - 0.6 (4.4 - 5.3)
	U/T1, V/T2, W/T3	2.5	2.5 - 4	8	M3 ⊖	0.5 - 0.6 (4.4 - 5.3)
	-, +1, +2	2.5	2.5 - 4	8	M3 ⊖	0.5 - 0.6 (4.4 - 5.3)
	B1, B2	2.5	2.5 - 4	8	M3 ⊖	0.5 - 0.6 (4.4 - 5.3)
	⊕	4	2.5 - 6	-	M4 ⊕	1.2 - 1.5 (10.6 - 13.3)

Model	Terminal	Recomm. Gauge mm ²	Applicable Gauge mm ²	Wire Stripping Length mm	Terminal Screw Size and Shape	Tightening Torque N·m (lbf·in)
4012	R/L1, S/L2, T/L3	2.5	2.5 - 4	10	M4 ⊖	1.5 - 1.7 (13.5 - 15)
	U/T1, V/T2, W/T3	2.5	2.5 - 4	10	M4 ⊖	1.5 - 1.7 (13.5 - 15)
	-, +1, +2	2.5	2.5 - 4	10	M4 ⊖	1.5 - 1.7 (13.5 - 15)
	B1, B2	2.5	2.5 - 4	10	M4 ⊖	1.5 - 1.7 (13.5 - 15)
	⊕	4	2.5 - 6	-	M4 ⊕	1.2 - 1.5 (10.6 - 13.3)
4018	R/L1, S/L2, T/L3	2.5	2.5 - 4	10	M4 ⊖	1.5 - 1.7 (13.5 - 15)
	U/T1, V/T2, W/T3	2.5	2.5 - 4	10	M4 ⊖	1.5 - 1.7 (13.5 - 15)
	-, +1, +2	4	2.5 - 6	10	M4 ⊖	1.5 - 1.7 (13.5 - 15)
	B1, B2	2.5	2.5 - 4	10	M4 ⊖	1.5 - 1.7 (13.5 - 15)
	⊕	4	2.5 - 16	-	M5 ⊕	2.0 - 2.5 (17.7 - 22.1)
4023	R/L1, S/L2, T/L3	4	2.5 - 6	10	M4 ⊖	1.5 - 1.7 (13.5 - 15)
	U/T1, V/T2, W/T3	4	2.5 - 6	10	M4 ⊖	1.5 - 1.7 (13.5 - 15)
	-, +1, +2	4	4 - 6	10	M4 ⊖	1.5 - 1.7 (13.5 - 15)
	B1, B2	2.5	2.5 - 4	10	M4 ⊖	1.5 - 1.7 (13.5 - 15)
	⊕	4	4 - 16	-	M5 ⊕	2.0 - 2.5 (17.7 - 22.1)

Model	Terminal	Recomm. Gauge mm ²	Applicable Gauge mm ²	Wire Stripping Length ^{*1} mm	Terminal Screw Size and Shape	Tightening Torque N-m (lbf-in)
4031	R/L1, S/L2, T/L3	6	4 - 10	10	M4 ⊖	1.5 - 1.7 (13.5 - 15)
	U/T1, V/T2, W/T3	6	4 - 10	10	M4 ⊖	1.5 - 1.7 (13.5 - 15)
	-, +1, +2	10	2.5 - 16	18	M5 ⊖	2.3 - 2.5 (19.8 - 22)
	B1, B2	2.5	2.5 - 4	10	M4 ⊖	1.5 - 1.7 (13.5 - 15)
	⊕	6	6 - 16	-	M6 ⊕	5.4 - 6.0 (47.8 - 53.1)
4038	R/L1, S/L2, T/L3	10	4 - 16	10	M4 ⊖	1.5 - 1.7 (13.5 - 15)
	U/T1, V/T2, W/T3	6	2.5 - 10	10	M4 ⊖	1.5 - 1.7 (13.5 - 15)
	-, +1, +2	16	4 - 25	18	M5 ⊖	2.3 - 2.5 (19.8 - 22)
	B1, B2	4	2.5 - 6	10	M4 ⊖	1.5 - 1.7 (13.5 - 15)
	⊕	10	6 - 16	-	M6 ⊕	5.4 - 6.0 (47.8 - 53.1)

*1 Remove insulation from the ends of wires to expose the length of wire shown.

■ Connect a Fuse to the Input Side (Primary Side)

The drive circuit protection must comply with EN 61800-5-1:2007 for protection against a short circuit in the internal circuitry. Connect semiconductor fuses on the input side for branch circuit protection.

Refer to [Single-Phase 200 V Class on page 187](#), [Three-Phase 200 V Class on page 187](#), and [Three-Phase 400 V Class on page 187](#) for more information about recommended fuses.

⚠ WARNING *Electrical Shock Hazard. After the drive blows a fuse or trips a GFCI, do not immediately energize the drive or operate peripheral devices. Wait for the time specified on the warning label at a minimum and make sure that all indicators are OFF. Then check the wiring and peripheral device ratings to find the cause of the problem. If you do not know the cause of the problem, contact Yaskawa before you energize the drive or peripheral devices. If you do not fix the problem before you operate the drive or peripheral devices, it can cause serious injury or death.*

Single-Phase 200 V Class

Table 16.3 Factory-Recommended Branch Circuit Protection: Single-Phase 200 V Class

Drive Model	Semiconductor Protection Fuse Rated Current Manufacturer: EATON/Bussmann	Drive Model	Semiconductor Protection Fuse Rated Current Manufacturer: EATON/Bussmann
B001	FWH-25A14F	B006	FWH-80B
B002	FWH-25A14F	B010	FWH-100B
B004	FWH-60B	B012	FWH-125B

Three-Phase 200 V Class

Table 16.4 Factory-Recommended Branch Circuit Protection: Three-Phase 200 V Class

Drive Model	Semiconductor Protection Fuse Rated Current Manufacturer: EATON/Bussmann	Drive Model	Semiconductor Protection Fuse Rated Current Manufacturer: EATON/Bussmann
2001	FWH-25A14F	2021	FWH-90B
2002	FWH-25A14F	2030	FWH-100B
2004	FWH-25A14F	2042	FWH-150B
2006	FWH-25A14F	2056	FWH-200B
2010	FWH-70B	2070	FWH-200B
2012	FWH-70B		

Three-Phase 400 V Class

Table 16.5 Factory-Recommended Branch Circuit Protection: Three-Phase 400 V Class

Drive Model	Semiconductor Protection Fuse Rated Current Manufacturer: EATON/Bussmann	Drive Model	Semiconductor Protection Fuse Rated Current Manufacturer: EATON/Bussmann
4001	FWH-40B	4004	FWH-50B
4002	FWH-40B	4005	FWH-70B

Drive Model	Semiconductor Protection Fuse Rated Current Manufacturer: EATON/Bussmann
4007	FWH-70B
4009	FWH-90B
4012	FWH-90B
4018	FWH-80B

Drive Model	Semiconductor Protection Fuse Rated Current Manufacturer: EATON/Bussmann
4023	FWH-100B
4031	FWH-125B
4038	FWH-175B

■ CE Standards Compliance for DC Power Supply Input

To comply with CE Standards, install a fuse for the DC power supply input.

Figure 16.3 shows a wiring example for a DC power supply that has two drives connected in parallel.

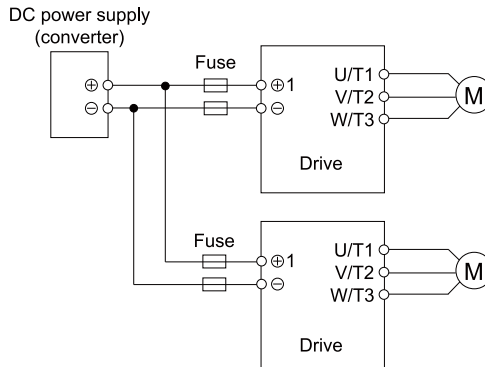

Figure 16.3 Wiring Example for DC Power Supply Input

⚠ WARNING *Electrical Shock Hazard. Do not ground the main circuit bus. Incorrect wiring can cause serious injury or death.*

Note:

- Install a fuse for each drive when operating more than one drive. If one fuse blows, replace all fuses.
- Install the external filter (system) to comply with the EMC Directive.

Refer to [Table 16.6](#), [Table 16.7](#), and [Table 16.8](#) for the recommended fuses.

Table 16.6 Recommended Fuse: Single-Phase 200 V Class

Drive Model	Fuse Manufacturer: Bussmann
	Model
B001	FWH-25A14F
B002	FWH-25A14F
B004	FWH-60B

Drive Model	Fuse Manufacturer: Bussmann
	Model
B006	FWH-80B
B010	FWH-100B
B012	FWH-125B

Table 16.7 Recommended Fuse: Three-Phase 200 V Class

Drive Model	Fuse Manufacturer: Bussmann
	Model
2001	FWH-25A14F
2002	FWH-25A14F
2004	FWH-25A14F
2006	FWH-25A14F
2010	FWH-70B
2012	FWH-70B

Drive Model	Fuse Manufacturer: Bussmann
	Model
2021	FWH-90B
2030	FWH-100B
2042	FWH-150B
2056	FWH-200B
2070	FWH-200B

Table 16.8 Recommended Fuse: Three-Phase 400 V Class

Drive Model	Fuse Manufacturer: Bussmann
	Model
4001	FWH-40B
4002	FWH-40B
4004	FWH-50B
4005	FWH-70B
4007	FWH-70B
4009	FWH-90B

Drive Model	Fuse Manufacturer: Bussmann
	Model
4012	FWH-90B
4018	FWH-80B
4023	FWH-100B
4031	FWH-125B
4038	FWH-175B

◆ EMC Directive

■ Installing the External EMC Noise Filter

Drive models BxxxA, 2xxxA, and 4xxxA must align with the conditions in this section to comply with EN 61800-3:2004/A1:2012.

Connect an EMC noise filter that complies with European standards as specified by Yaskawa to the input side (primary side). Refer to [External EMC Noise Filter Selection on page 193](#) to select the correct EMC noise filter.

Use this procedure to install an EMC noise filter to make equipment and devices added to the drive comply with the EMC Directive.

1. Install the drive and EMC noise filter on the same grounded metal plate.
2. Wire the drive and motor.
3. Ground the wire shielding on the drive side and motor side.

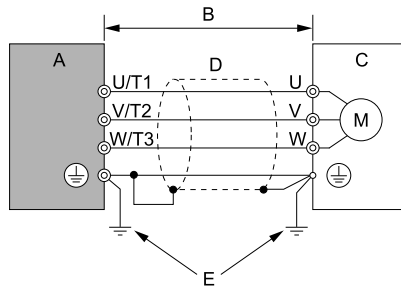

- | | |
|-----------------------------------|---------------------------|
| A - Drive | D - Metal conduit |
| B - 10 m (32.8 ft) maximum | E - Grounding wire |
| C - Motor | |

Figure 16.4 Wiring the Drive and Motor

Note:

- Use a braided shield cable for the drive and motor wiring or put the wires through a metal conduit.
- Keep the wire as short as possible. The maximum wiring length between the drive and motor is:
 - BxxxA, 2xxxA, 4xxxA: 10 m (32.8 ft)
- Keep the grounding wire as short as possible.

4. Use a cable clamp to ground the motor cable to the metal plate.

Note:

Make sure that the protective ground wire complies with technical specifications or local safety standards.

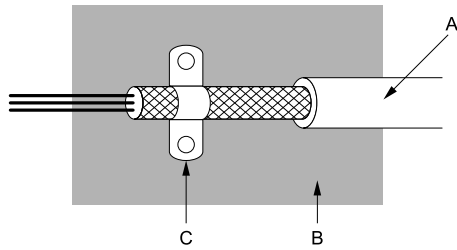

A - Braided shield cable
B - Metal plate

C - Cable clamp (conductive)

Figure 16.5 Ground the Shield

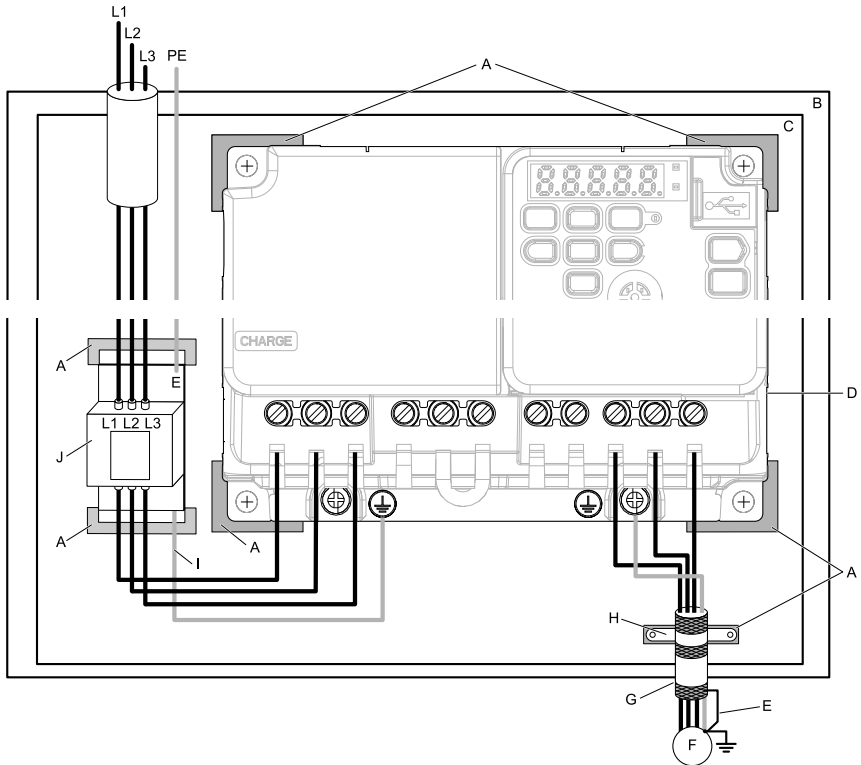

- | | |
|---|--|
| <ul style="list-style-type: none"> A - Grounding surface (Remove any paint or sealant.) B - Enclosure panel C - Metal plate D - Drive E - Ground the shield. | <ul style="list-style-type: none"> F - Motor G - Motor cable (Braided shield cable: 10 m (32.8 ft) maximum) H - Cable clamp I - Grounding wire J - EMC noise filter |
|---|--|

Figure 16.6 EMC Noise Filter and Drive Installation Procedure

5. Connect the DC link choke to decrease harmonic distortion.
Refer to [DC Link Chokes on page 194](#) to select a DC link choke.

Note:

- To comply with EN 61000-3-2 on drive models 2001 to 2006, and 4001 to 4004, install a DC link choke.
- The terminal block for the drive main circuit and the terminal block for the DC link choke have different shapes. The drive has a European-style terminal block, and the DC link choke has a round terminal block. Correctly prepare the ends of the wiring.

Ground Wiring

⚠ WARNING *Electrical Shock Hazard. Do not remove covers or touch circuit boards while the drive is energized. If you touch the internal components of an energized drive, it can cause serious injury or death.*

External EMC Noise Filter Selection**Table 16.9 External EMC Noise Filter (BxxxA)**

Drive model	EMC Noise Filter Model	Quantity	Manufacturer
B001	FS23638-10-07	1	Schaffner
B002	FS23638-10-07	1	Schaffner
B004	FS23638-10-07	1	Schaffner
B006	FS23638-20-07	1	Schaffner
B010	FS23638-20-07	1	Schaffner
B012	FS23638-30-07	1	Schaffner

Table 16.10 External EMC Noise Filter (2xxxA)

Drive model	EMC Noise Filter Model	Quantity	Manufacturer
2001	FS23637-8-07	1	Schaffner
2002	FS23637-8-07	1	Schaffner
2004	FS23637-8-07	1	Schaffner
2006	FS23637-8-07	1	Schaffner
2010	FS23637-14-07	1	Schaffner
2012	FS23637-14-07	1	Schaffner
2021	FS23637-24-07	1	Schaffner
2030	FS5973-35-07	1	Schaffner
2042	FS5973-60-07	1	Schaffner

Drive model	EMC Noise Filter Model	Quantity	Manufacturer
2056	FS5973-100-07	1	Schaffner
2070	FS5973-100-07	1	Schaffner

Table 16.11 External EMC Noise Filter (4xxxA)

Drive model	EMC Noise Filter Model	Quantity	Manufacturer
4001	FS23639-5-07	1	Schaffner
4002	FS23639-5-07	1	Schaffner
4004	FS23639-5-07	1	Schaffner
4005	FS23639-10-07	1	Schaffner
4007	FS23639-10-07	1	Schaffner
4009	FS23639-10-07	1	Schaffner
4012	FS23639-15-07	1	Schaffner
4018	FS5972-35-07	1	Schaffner
4023	FS5972-35-07	1	Schaffner
4031	FS5972-60-07	1	Schaffner
4038	FS5972-60-07	1	Schaffner

■ DC Link Chokes

To comply with EN 61000-3-2 drive models 2001 to 2006, and 4001 to 4004, install a DC link choke when you use an internal or external EMC filter. Refer to [Table 16.12](#) to select a DC link choke.

Table 16.12 DC Link Chokes for Harmonic Suppression

Drive Model	DC Link Choke
	Rating
2001 - 2006	5.4 A, 8 mA
4001 - 4004	3.2 A, 28 mA

17 UL Standards



Figure 17.1 Recognized Component Mark

The Recognized Component Mark indicates that this product satisfies stringent safety standards. This mark appears on products in the United States and Canada. It shows UL approval, indicating that it has been determined that the product complies with safety standards after undergoing strict inspection and assessment.

You must use UL Listed or UL Recognized parts for all primary components that are built into electrical equipment that has UL approval.

This product has been tested in accordance with UL standard UL61800-5-1, and has been verified to be in compliance with UL standards.

◆ Conditions of Acceptability

Machines and devices integrated with this product must satisfy the following conditions for compliance with UL standards.

1. Install finless-type drives into a ventilated enclosure with a minimum enclosure volume shown in [Table 17.1](#).

Table 17.1 Minimum Enclosure Volume

Model	Minimum Volume cm ³ (in ³)
B001 - B006 2001 - 2012	9850 (600)
B010 - B012 2018 - 2042 4001 - 4023	15750 (960)
2056 - 2070 4031, 4038	42000 (2560)

2. Keep the ambient temperature lower than 35 °C (95 °F) in your application.
3. Keep the drive heatsink plate temperature lower than the maximum temperature shown in [Table 17.2](#) in your application.
Use U4-08 [*Heatsink Temperature*] to monitor the drive heatsink temperature.

Table 17.2 Maximum Temperature of the Heatsink Plate

Model	Maximum Temperature of the Heatsink Plate
B001 - B012	90 °C (194 °F)
2001 - 2021	90 °C (194 °F)
2030 - 2070	80 °C (176 °F)
4001 - 4012	90 °C (194 °F)
4018 - 4038	80 °C (176 °F)

4. Make sure that the metal surface to which you will install the drive meets these specifications:
 - Flatness: ≤ 0.2 mm (0.0078 in)
 - Roughness: ≤ 25 S
5. Make sure that there is sufficient space for wiring and airflow to cool the drive.
 - 30 mm (1.18 in) minimum from each side
 - 100 mm (3.94 in) minimum from top and bottom
6. The recommended thermal compound is X-23-7795 from Shin-Etsu Chemical Co., Ltd. Apply 100 μ m to 250 μ m of thermal compound evenly over the full heatsink plate of the drive.
7. Use the correct screws to safety the drive to a metal surface (enclosure panel). [Table 17.3](#) shows the screw sizes and tightening torques. Monitor the temperature of the external heatsink at the top center of the junction between the external heatsink and the drive.

Table 17.3 Screw Sizes and Tightening Torques

Drive Model	Screw Size	Tightening Torque N·m (lbf·in)
B001 - B012	M5	2.0 - 2.5 (17.7 - 22.1)
2001 - 2021	M5	2.0 - 2.5 (17.7 - 22.1)
2030 - 2056	M5	2.0 - 2.5 (17.7 - 22.1)
2070	M6	4.0 - 5.0 (35.4 - 44.3)

Drive Model	Screw Size	Tightening Torque N·m (lbf·in)
4001 - 4012	M5	2.0 - 2.5 (17.7 - 22.1)
4018 - 4038	M5	2.0 - 2.5 (17.7 - 22.1)

◆ Area of Use

Install this product in a location with Overvoltage Category III and pollution degree 2 or less as specified in UL61800-5-1.

■ Ambient Temperature

Keep the ambient temperature in this range:

- -10 °C to +35 °C (14 °F to 95 °F)

◆ Wire the Main Circuit Terminal Block

Wire the main circuit terminal block correctly as specified by the instructions in the manual.

To select the correct wire gauge, refer to [Main Circuit Wire Gauges and Tightening Torques on page 197](#).

■ Notes on Wiring the Main Circuit Terminal Block

Refer to [Notes on Wiring the Main Circuit Terminal Block on page 55](#) for more information.

■ Main Circuit Wire Gauges and Tightening Torques

Refer to [Single-Phase 200 V Class on page 199](#), [Three-Phase 200 V Class on page 201](#), and [Three-Phase 400 V Class on page 205](#) for the recommended wire gauges and tightening torques of the main circuit terminals.

Comply with local standards for correct wire gauges in the region where you will use the drive.

▲ WARNING *Electrical Shock Hazard. Only connect factory-recommended devices or circuits to drive terminals B1, B2, -, +1, and +2. Do not connect AC power to these terminals. Incorrect wiring can cause damage to the drive and serious injury or death from fire.*

Note:

- The recommended wire gauges are based on drive continuous current ratings with 75 °C (167 °F) 600 V class 2 heat-resistant indoor PVC wire. Assume these conditions:
 - Ambient temperature: 40 °C (104 °F) maximum
 - Wiring distance: 100 m (3281 ft) maximum
 - Normal Duty rated current value
- Refer to the instruction manual for each device for recommended wire gauges to connect peripheral devices or options to terminals +1, +2, -, B1, and B2. Contact Yaskawa or your nearest sales representative if the recommended wire gauges for the peripheral devices or options are out of the range of the applicable gauges for the drive.

Wire Selection Precautions

Think about line voltage drop before selecting wire gauges. Select wire gauges that drop the voltage by 2% or less of the rated voltage. Increase the wire gauge and the cable length when the risk of voltage drops increases. Calculate line voltage drop with this formula:

$$\text{Line voltage drop (V)} = \sqrt{3} \times \text{wire resistance } (\Omega/\text{km}) \times \text{wiring distance (m)} \times \text{motor rated current (A)} \times 10^{-3}.$$

Precautions during Wiring



- Refer to “Yaskawa AC Drive Option Braking Unit, Braking Resistor Unit Instruction Manual (TOBPC72060001)” for information about wire gauges and tightening torques to connect braking resistor units.
- Use terminals +1 and - to connect a regenerative converter or regenerative unit.

▲ WARNING *Fire Hazard. Do not connect a braking resistor to terminals +1 or -. Use terminals B1 and B2 for the braking resistor connections. If you connect a braking resistor to the incorrect terminals, it can cause damage to the drive and braking circuit and serious injury or death.*



















Screw Shape

These tables use icons in [Table 17.4](#) to show the shapes of the screw heads.

Table 17.4 Icons to Identify Screw Shapes

Icon	Screw Shape
	Phillips/slot combo (+/-)
	Slotted (-)
	Hex socket cap (WAF: 5 mm)



















Single-Phase 200 V Class



















Model	Terminal	Recomm. Gauge AWG, kcmil	Applicable Gauge AWG, kcmil	Wire Stripping Length ^{*1} mm	Terminal Screw Size and Shape	Tightening Torque N·m (lbf·in)
B001	L/L1, N/L2	14	14	6.5	M3 	0.5 - 0.6 (4.4 - 5.3)
	U/T1, V/T2, W/T3	14	14	6.5	M3 	0.5 - 0.6 (4.4 - 5.3)
	-, +1	14	14	6.5	M3 	0.5 - 0.6 (4.4 - 5.3)
	B1, B2	14	14	6.5	M3 	0.5 - 0.6 (4.4 - 5.3)
		14	14	-	M3.5 	0.8 - 1.0 (7.1 - 8.9)
B002	L/L1, N/L2	14	14	6.5	M3 	0.5 - 0.6 (4.4 - 5.3)
	U/T1, V/T2, W/T3	14	14	6.5	M3 	0.5 - 0.6 (4.4 - 5.3)
	-, +1	14	14	6.5	M3 	0.5 - 0.6 (4.4 - 5.3)
	B1, B2	14	14	6.5	M3 	0.5 - 0.6 (4.4 - 5.3)
		14	14	-	M3.5 	0.8 - 1.0 (7.1 - 8.9)
B004	L/L1, N/L2	14	14	6.5	M3 	0.5 - 0.6 (4.4 - 5.3)
	U/T1, V/T2, W/T3	14	14	6.5	M3 	0.5 - 0.6 (4.4 - 5.3)
	-, +1	14	14	6.5	M3 	0.5 - 0.6 (4.4 - 5.3)
	B1, B2	14	14	6.5	M3 	0.5 - 0.6 (4.4 - 5.3)
		14	14	-	M3.5 	0.8 - 1.0 (7.1 - 8.9)

Model	Terminal	Recomm. Gauge AWG, kcmil	Applicable Gauge AWG, kcmil	Wire Stripping Length *1 mm	Terminal Screw Size and Shape	Tightening Torque N·m (lbf·in)
B006	L/L1, N/L2	12	14 - 10	8	M3 ⊖	0.5 - 0.6 (4.4 - 5.3)
	U/T1, V/T2, W/T3	14	14 - 12	8	M3 ⊖	0.5 - 0.6 (4.4 - 5.3)
	-, +1	12	14 - 10	8	M3 ⊖	0.5 - 0.6 (4.4 - 5.3)
	B1, B2	14	14 - 12	8	M3 ⊖	0.5 - 0.6 (4.4 - 5.3)
	⊕	10	14 - 10	-	M4 ⊕	1.2 - 1.5 (10.6 - 13.3)
B010	L/L1, N/L2	10	12 - 10	8	M3 ⊖	0.5 - 0.6 (4.4 - 5.3)
	U/T1, V/T2, W/T3	14	14 - 12	8	M3 ⊖	0.5 - 0.6 (4.4 - 5.3)
	-, +1	10	12 - 10	8	M3 ⊖	0.5 - 0.6 (4.4 - 5.3)
	B1, B2	14	14 - 12	8	M3 ⊖	0.5 - 0.6 (4.4 - 5.3)
	⊕	10	14 - 10	-	M4 ⊕	1.2 - 1.5 (10.6 - 13.3)
B012	L/L1, N/L2	8	14 - 8	10	M4 ⊖	1.5 - 1.7 (13.5 - 15)
	U/T1, V/T2, W/T3	12	14 - 10	10	M4 ⊖	1.5 - 1.7 (13.5 - 15)
	-, +1	8	14 - 8	10	M4 ⊖	1.5 - 1.7 (13.5 - 15)
	B1, B2	14	14 - 12	10	M4 ⊖	1.5 - 1.7 (13.5 - 15)
	⊕	10	14 - 10	-	M4 ⊕	1.2 - 1.5 (10.6 - 13.3)













*1 Remove insulation from the ends of wires to expose the length of wire shown.

Three-Phase 200 V Class

Model	Terminal	Recomm. Gauge AWG, kcmil	Applicable Gauge AWG, kcmil	Wire Stripping Length ^{*1} mm	Terminal Screw Size and Shape	Tightening Torque N·m (lbf·in)
2001	R/L1, S/L2, T/L3	14	14	6.5	M3 	0.5 - 0.6 (4.4 - 5.3)
	U/T1, V/T2, W/T3	14	14	6.5	M3 	0.5 - 0.6 (4.4 - 5.3)
	-, +1, +2	14	14	6.5	M3 	0.5 - 0.6 (4.4 - 5.3)
	B1, B2	14	14	6.5	M3 	0.5 - 0.6 (4.4 - 5.3)
		14	14	-	M3.5 	0.8 - 1.0 (7.1 - 8.9)
2002	R/L1, S/L2, T/L3	14	14	6.5	M3 	0.5 - 0.6 (4.4 - 5.3)
	U/T1, V/T2, W/T3	14	14	6.5	M3 	0.5 - 0.6 (4.4 - 5.3)
	-, +1, +2	14	14	6.5	M3 	0.5 - 0.6 (4.4 - 5.3)
	B1, B2	14	14	6.5	M3 	0.5 - 0.6 (4.4 - 5.3)
		14	14	-	M3.5 	0.8 - 1.0 (7.1 - 8.9)
2004	R/L1, S/L2, T/L3	14	14	6.5	M3 	0.5 - 0.6 (4.4 - 5.3)
	U/T1, V/T2, W/T3	14	14	6.5	M3 	0.5 - 0.6 (4.4 - 5.3)
	-, +1, +2	14	14	6.5	M3 	0.5 - 0.6 (4.4 - 5.3)
	B1, B2	14	14	6.5	M3 	0.5 - 0.6 (4.4 - 5.3)
		14	14	-	M3.5 	0.8 - 1.0 (7.1 - 8.9)



















Model	Terminal	Recomm. Gauge AWG, kcmil	Applicable Gauge AWG, kcmil	Wire Stripping Length mm	Terminal Screw Size and Shape	Tightening Torque N-m (lbf-in)
2006	R/L1, S/L2, T/L3	14	14	6.5	M3 	0.5 - 0.6 (4.4 - 5.3)
	U/T1, V/T2, W/T3	14	14	6.5	M3 	0.5 - 0.6 (4.4 - 5.3)
	-, +1, +2	14	14	6.5	M3 	0.5 - 0.6 (4.4 - 5.3)
	B1, B2	14	14	6.5	M3 	0.5 - 0.6 (4.4 - 5.3)
		14	14	-	M3.5 	0.8 - 1.0 (7.1 - 8.9)
2010	R/L1, S/L2, T/L3	14	14 - 12	8	M3 	0.5 - 0.6 (4.4 - 5.3)
	U/T1, V/T2, W/T3	14	14 - 12	8	M3 	0.5 - 0.6 (4.4 - 5.3)
	-, +1, +2	12	14 - 10	8	M3 	0.5 - 0.6 (4.4 - 5.3)
	B1, B2	14	14 - 12	8	M3 	0.5 - 0.6 (4.4 - 5.3)
		10	14 - 10	-	M4 	1.2 - 1.5 (10.6 - 13.3)
2012	R/L1, S/L2, T/L3	12	14 - 10	8	M3 	0.5 - 0.6 (4.4 - 5.3)
	U/T1, V/T2, W/T3	12	14 - 10	8	M3 	0.5 - 0.6 (4.4 - 5.3)
	-, +1, +2	10	12 - 10	8	M3 	0.5 - 0.6 (4.4 - 5.3)
	B1, B2	14	14 - 12	8	M3 	0.5 - 0.6 (4.4 - 5.3)
		10	14 - 10	-	M4 	1.2 - 1.5 (10.6 - 13.3)



















Model	Terminal	Recomm. Gauge AWG, kcmil	Applicable Gauge AWG, kcmil	Wire Stripping Length mm	Terminal Screw Size and Shape	Tightening Torque N·m (lbf·in)
2021	R/L1, S/L2, T/L3	8	14 - 8	10	M4 ⊖	1.5 - 1.7 (13.5 - 15)
	U/T1, V/T2, W/T3	10	14 - 8	10	M4 ⊖	1.5 - 1.7 (13.5 - 15)
	-, +1, +2	8	14 - 8	10	M4 ⊖	1.5 - 1.7 (13.5 - 15)
	B1, B2	14	14 - 10	10	M4 ⊖	1.5 - 1.7 (13.5 - 15)
	⊕	8	14 - 8	-	M4 ⊕	1.2 - 1.5 (10.6 - 13.3)
2030	R/L1, S/L2, T/L3	8	12 - 6	10	M4 ⊖	1.5 - 1.7 (13.5 - 15)
	U/T1, V/T2, W/T3	8	12 - 6	10	M4 ⊖	1.5 - 1.7 (13.5 - 15)
	-, +1, +2	6	12 - 6	10	M4 ⊖	1.5 - 1.7 (13.5 - 15)
	B1, B2	12	12 - 8	10	M4 ⊖	1.5 - 1.7 (13.5 - 15)
	⊕	8	10 - 6	-	M5 ⊕	2.0 - 2.5 (17.7 - 22.1)
2042	R/L1, S/L2, T/L3	6	12 - 6	10	M4 ⊖	1.5 - 1.7 (13.5 - 15)
	U/T1, V/T2, W/T3	6	12 - 6	10	M4 ⊖	1.5 - 1.7 (13.5 - 15)
	-, +1, +2	4	10 - 2	18	M5 ⊖	<ul style="list-style-type: none"> • ≤ AWG 10 2.3 - 2.5 (19.8 - 22) • AWG 8 ≤ 4.1 - 4.5 (36 - 40)
	B1, B2	10	14 - 6	10	M4 ⊖	1.5 - 1.7 (13.5 - 15)
	⊕	6	10 - 6	-	M5 ⊕	2.0 - 2.5 (17.7 - 22.1)

Model	Terminal	Recomm. Gauge AWG, kcmil	Applicable Gauge AWG, kcmil	Wire Stripping Length mm	Terminal Screw Size and Shape	Tightening Torque N-m (lbf-in)
2056	R/L1, S/L2, T/L3	4	10 - 2	18	M5 	4.1 - 4.5 (36 - 40)
	U/T1, V/T2, W/T3	4	10 - 2	18	M5 	<ul style="list-style-type: none"> • ≤ AWG 10 2.3 - 2.5 (19.8 - 22) • AWG 8 ≤ 4.1 - 4.5 (36 - 40)
	-, +1, +2	2	8 - 2	18	M5 	4.1 - 4.5 (36 - 40)
	B1, B2	8	12 - 6	10	M4 	1.5 - 1.7 (13.5 - 15)
		6	8 - 4	-	M6 	5.4 - 6.0 (47.8 - 53.1)
2070	R/L1, S/L2, T/L3	2	6 - 1	20	M6 	5 - 5.5 (45 - 49)
	U/T1, V/T2, W/T3	2	8 - 1	20	M6 	5 - 5.5 (45 - 49)
	-, +1, +2	1	6 - 1/0	20	M6 	5 - 5.5 (45 - 49)
	B1, B2	8	12 - 6	10	M4 	1.5 - 1.7 (13.5 - 15)
		4	6 - 4	-	M6 	5.4 - 6.0 (47.8 - 53.1)

*1 Remove insulation from the ends of wires to expose the length of wire shown.

Three-Phase 400 V Class

Model	Terminal	Recomm. Gauge AWG, kcmil	Applicable Gauge AWG, kcmil	Wire Stripping Length ^{*)} mm	Terminal Screw Size and Shape	Tightening Torque N-m (lbf-in)
4001	R/L1, S/L2, T/L3	14	14 - 12	8	M3 	0.5 - 0.6 (4.4 - 5.3)
	U/T1, V/T2, W/T3	14	14 - 12	8	M3 	0.5 - 0.6 (4.4 - 5.3)
	-, +1, +2	14	14 - 12	8	M3 	0.5 - 0.6 (4.4 - 5.3)
	B1, B2	14	14 - 12	8	M3 	0.5 - 0.6 (4.4 - 5.3)
		14	14 - 10	-	M4 	1.2 - 1.5 (10.6 - 13.3)
4002	R/L1, S/L2, T/L3	14	14 - 12	8	M3 	0.5 - 0.6 (4.4 - 5.3)
	U/T1, V/T2, W/T3	14	14 - 12	8	M3 	0.5 - 0.6 (4.4 - 5.3)
	-, +1, +2	14	14 - 12	8	M3 	0.5 - 0.6 (4.4 - 5.3)
	B1, B2	14	14 - 12	8	M3 	0.5 - 0.6 (4.4 - 5.3)
		14	14 - 10	-	M4 	1.2 - 1.5 (10.6 - 13.3)
4004	R/L1, S/L2, T/L3	14	14 - 12	8	M3 	0.5 - 0.6 (4.4 - 5.3)
	U/T1, V/T2, W/T3	14	14 - 12	8	M3 	0.5 - 0.6 (4.4 - 5.3)
	-, +1, +2	14	14 - 12	8	M3 	0.5 - 0.6 (4.4 - 5.3)
	B1, B2	14	14 - 12	8	M3 	0.5 - 0.6 (4.4 - 5.3)
		10	14 - 10	-	M4 	1.2 - 1.5 (10.6 - 13.3)

Model	Terminal	Recomm. Gauge AWG, kcmil	Applicable Gauge AWG, kcmil	Wire Stripping Length mm	Terminal Screw Size and Shape	Tightening Torque N-m (lbf-in)
4005	R/L1, S/L2, T/L3	14	14 - 12	8	M3 	0.5 - 0.6 (4.4 - 5.3)
	U/T1, V/T2, W/T3	14	14 - 12	8	M3 	0.5 - 0.6 (4.4 - 5.3)
	-, +1, +2	14	14 - 12	8	M3 	0.5 - 0.6 (4.4 - 5.3)
	B1, B2	14	14 - 12	8	M3 	0.5 - 0.6 (4.4 - 5.3)
		10	14 - 10	-	M4 	1.2 - 1.5 (10.6 - 13.3)
4007	R/L1, S/L2, T/L3	14	14 - 12	8	M3 	0.5 - 0.6 (4.4 - 5.3)
	U/T1, V/T2, W/T3	14	14 - 12	8	M3 	0.5 - 0.6 (4.4 - 5.3)
	-, +1, +2	14	14 - 12	8	M3 	0.5 - 0.6 (4.4 - 5.3)
	B1, B2	14	14 - 12	8	M3 	0.5 - 0.6 (4.4 - 5.3)
		10	14 - 10	-	M4 	1.2 - 1.5 (10.6 - 13.3)
4009	R/L1, S/L2, T/L3	14	14 - 12	8	M3 	0.5 - 0.6 (4.4 - 5.3)
	U/T1, V/T2, W/T3	14	14 - 12	8	M3 	0.5 - 0.6 (4.4 - 5.3)
	-, +1, +2	14	14 - 12	8	M3 	0.5 - 0.6 (4.4 - 5.3)
	B1, B2	14	14 - 12	8	M3 	0.5 - 0.6 (4.4 - 5.3)
		10	14 - 10	-	M4 	1.2 - 1.5 (10.6 - 13.3)

Model	Terminal	Recomm. Gauge AWG, kcmil	Applicable Gauge AWG, kcmil	Wire Stripping Length mm	Terminal Screw Size and Shape	Tightening Torque N·m (lbf·in)
4012	R/L1, S/L2, T/L3	12	14 - 10	10	M4 ⊖	1.5 - 1.7 (13.5 - 15)
	U/T1, V/T2, W/T3	14	14 - 12	10	M4 ⊖	1.5 - 1.7 (13.5 - 15)
	-, +1, +2	10	12 - 8	10	M4 ⊖	1.5 - 1.7 (13.5 - 15)
	B1, B2	14	14 - 12	10	M4 ⊖	1.5 - 1.7 (13.5 - 15)
	⊕	10	14 - 10	-	M4 ⊕	1.2 - 1.5 (10.6 - 13.3)
4018	R/L1, S/L2, T/L3	10	12 - 8	10	M4 ⊖	1.5 - 1.7 (13.5 - 15)
	U/T1, V/T2, W/T3	10	12 - 8	10	M4 ⊖	1.5 - 1.7 (13.5 - 15)
	-, +1, +2	10	14 - 8	10	M4 ⊖	1.5 - 1.7 (13.5 - 15)
	B1, B2	14	14 - 12	10	M4 ⊖	1.5 - 1.7 (13.5 - 15)
	⊕	10	14 - 6	-	M5 ⊕	2.0 - 2.5 (17.7 - 22.1)
4023	R/L1, S/L2, T/L3	8	14 - 6	10	M4 ⊖	1.5 - 1.7 (13.5 - 15)
	U/T1, V/T2, W/T3	10	14 - 8	10	M4 ⊖	1.5 - 1.7 (13.5 - 15)
	-, +1, +2	8	12 - 6	10	M4 ⊖	1.5 - 1.7 (13.5 - 15)
	B1, B2	12	14 - 10	10	M4 ⊖	1.5 - 1.7 (13.5 - 15)
	⊕	10	10 - 6	-	M5 ⊕	2.0 - 2.5 (17.7 - 22.1)

Model	Terminal	Recomm. Gauge AWG, kcmil	Applicable Gauge AWG, kcmil	Wire Stripping Length mm	Terminal Screw Size and Shape	Tightening Torque N-m (lbf-in)
4031	R/L1, S/L2, T/L3	8	12 - 6	10	M4 ⊖	1.5 - 1.7 (13.5 - 15)
	U/T1, V/T2, W/T3	8	12 - 6	10	M4 ⊖	1.5 - 1.7 (13.5 - 15)
	-, +1, +2	6	12 - 4	18	M5 ⊖	<ul style="list-style-type: none"> • ≤ AWG 10 2.3 - 2.5 (19.8 - 22) • AWG 8 ≤ 4.1 - 4.5 (36 - 40)
	B1, B2	10	12 - 8	10	M4 ⊖	1.5 - 1.7 (13.5 - 15)
	⊕	8	10 - 6	-	M6 ⊕	5.4 - 6.0 (47.8 - 53.1)
4038	R/L1, S/L2, T/L3	6	12 - 6	10	M4 ⊖	1.5 - 1.7 (13.5 - 15)
	U/T1, V/T2, W/T3	8	12 - 6	10	M4 ⊖	1.5 - 1.7 (13.5 - 15)
	-, +1, +2	4	10 - 2	18	M5 ⊖	<ul style="list-style-type: none"> • ≤ AWG 10 2.3 - 2.5 (19.8 - 22) • AWG 8 ≤ 4.1 - 4.5 (36 - 40)
	B1, B2	10	14 - 6	10	M4 ⊖	1.5 - 1.7 (13.5 - 15)
	⊕	6	10 - 6	-	M6 ⊕	5.4 - 6.0 (47.8 - 53.1)

*1 Remove insulation from the ends of wires to expose the length of wire shown.

■ Short Circuit Protection

Install one of these types of short circuit protection devices in [Table 17.5](#), [Table 17.6](#), and [Table 17.7](#) to comply with UL 61800-5-1. Semiconductor protective type fuses are recommended, but the table also shows alternative short circuit protection devices.

- Molded Case Circuit Breaker (MCCB) Ratings
 - Maximum MCCB rating is 200% of the Normal-Duty drive full load output amp (FLA) rating.
 - When you use MCCBs you must mount the drive in a ventilated enclosure according to the minimum enclosure volume specified in this document.

Note:

When you use MCCBs, Yaskawa recommends Schneider Powerpact current limiting MCCBs.

- Non-Semiconductor Fuse Ratings
Maximum CC, J, T or RK5 fuse rating is 175% of the Normal-Duty drive full load output amp (FLA) rating.
- Short Circuit Current Rating (SCCR)
The maximum SCCR provided by drive and fuse, or drive and MCCB combinations in this document, is 31,000 RMS symmetrical amps.
 - 200 V models: Use the protection specified in this document to prepare the drive for use on a circuit capable of delivering not more than 31,000 RMS symmetrical amps and not more than 240 Vac.
 - 400 V models: Use the protection specified in this document to prepare the drive for use on a circuit capable of delivering not more than 31,000 RMS symmetrical amps and not more than 480 Vac.

Table 17.5 Required Short Circuit Protection for GA500 Finless-Type Drive: Single-Phase 200 V Class

Drive Model	Semiconductor Fuse Part Number Manufacturer: Eaton/ Bussman	Class CC, J or T Fuse Maximum Amps	MCCB (Schneider Powerpact current limiting MCCB)	Class RK5 Fuse Maximum Amps	Enclosure Volume Minimum (in ³)
B001	FWH-25A14F	3.5	HLL36015	3.5	600
B002	FWH-25A14F	6	HLL36015	6	600
B004	FWH-60B	12	HLL36015	12	600
B006	FWH-80B	20	HLL36025	20	600
B010	FWH-100B	35	HLL36040	35	960
B012	FWH-125B	40	HLL36045	40	960

Table 17.6 Required Short Circuit Protection for GA500 Finless-Type Drive: Three-Phase 200 V Class

Drive Model	Semiconductor Fuse Part Number Manufacturer: Eaton/ Bussman	Class CC, J or T Fuse Maximum Amps	MCCB (Schneider Powerpact current limiting MCCB)	Class RK5 Fuse Maximum Amps	Enclosure Volume Minimum (in ³)
2001	FWH-25A14F	2	HLL36015	2	600
2002	FWH-25A14F	3.2	HLL36015	3.2	600
2004	FWH-25A14F	6	HLL36015	6	600
2006	FWH-25A14F	10	HLL36015	10	600
2008	FWH-70B	12	HLL36015	12	600
2010	FWH-70B	15	HLL36015	15	600
2012	FWH-70B	20	HLL36020	20	600
2018	FWH-90B	30	HLL36035	30	960
2021	FWH-90B	35	HLL36040	35	960
2030	FWH-100B	50	-	-	960
2042	FWH-150B	70	-	-	960
2056	FWH-200B	90	-	-	2560
2070	FWH-200B	110	-	-	2560

Table 17.7 Required Short Circuit Protection for GA500 Finless-Type Drive: Three-Phase 400 V Class

Drive Model	Semiconductor Fuse Part Number Manufacturer: Eaton/ Bussman	Class CC, J or T Fuse Maximum Amps	MCCB (Schneider Powerpact current limiting MCCB)	Class RK5 Fuse Maximum Amps	Enclosure Volume Minimum (in ³)
4001	FWH-40B	2	HLL36015	2	960
4002	FWH-40B	3.5	HLL36015	3.5	960
4004	FWH-50B	7	HLL36015	7	960
4005	FWH-70B	9	HLL36015	9	960
4007	FWH-70B	12	HLL36015	12	960

Drive Model	Semiconductor Fuse Part Number Manufacturer: Eaton/ Bussman	Class CC, J or T Fuse Maximum Amps	MCCB (Schneider Powerpact current limiting MCCB)	Class RK5 Fuse Maximum Amps	Enclosure Volume Minimum (in ³)
4009	FWH-80B or FWH-90B	15	HLL36015	15	960
4012	FWH-80B or FWH-90B	20	HLL36020	20	960
4018	FWH-80B	30	-	-	960
4023	FWH-100B	40	-	-	960
4031	FWH-125B	50	-	-	2560
4038	FWH-175B	60	-	-	2560

Electric Code Compliance

The user must provide short circuit protection to protect input branch circuits as specified by the National Electric Code (NEC), the Canadian Electric Code, Part 1 (CEC), and local codes.

◆ Low Voltage Wiring for Control Circuit Terminals

You must provide low voltage wiring as specified by the National Electric Code (NEC), the Canadian Electric Code, Part 1 (CEC), and local codes. Yaskawa recommends the NEC class 1 circuit conductor. Use the UL approved class 2 power supply for external power supply.

Table 17.8 Control Circuit Terminal Power Supplies

Input/Output	Terminals	Power Supply Specifications
Digital input	S1 to S7, SN, SC, SP	Uses the LVLC power supply in the drive. Use the UL Listed class 2 power supply for external power supply.
Analog input	A1, A2, AC, +V	Uses the LVLC power supply in the drive. Use the UL Listed class 2 power supply for external power supply.
Analog output	AM, AC	Uses the LVLC power supply in the drive.

Input/Output	Terminals	Power Supply Specifications
Pulse train output	MP, AC	Uses the LVLC power supply in the drive. Use the UL Listed class 2 power supply for external power supply.
Pulse train input	RP, AC	Uses the LVLC power supply in the drive. Use the UL Listed class 2 power supply for external power supply.
Safe disable input	H1, H2, HC	Uses the LVLC power supply in the drive. Use the UL Listed class 2 power supply for external power supply.
Serial communication input/output	D+, D-, AC	Uses the LVLC power supply in the drive. Use the UL Listed class 2 power supply for external power supply.
24 V external power supply	PS, AC	Use the UL Listed class 2 power supply.
Multi-Function Photocoupler Output	P1, C1, P2, C2	Uses the LVLC power supply in the drive. Use the UL Listed class 2 power supply for external power supply.

◆ **Drive Motor Overload and Overheat Protection**

The drive motor overload and overheat protection function complies with the National Electric Code (NEC) and the Canadian Electric Code, Part I (CEC).

Set the Motor Rated Current and *L1-01 through L1-04 [Motor Overload Protection Select]* correctly to enable motor overload and overheat protection.

Refer to the control method and set the motor rated current with *E2-01 [Motor Rated Current (FLA)]*, *E5-03 [PM Motor Rated Current (FLA)]*, or *E9-06 [Motor Rated Current (FLA)]*.

■ **E2-01: Motor Rated Current (FLA)**

No. (Hex.)	Name	Description	Default (Range)
E2-01 (030E)	Motor Rated Current (FLA)	<div style="display: flex; gap: 5px;"> V/f OLV OLV/PM AOLV/PM EZOLV </div> <p>Sets the motor rated current in amps.</p>	Determined by o2-04, C6-01 (10% to 200% of the drive rated current)

Note:

- If $E2-01 < E2-03$ [Motor No-Load Current], the drive will detect $oPE02$ [Parameter Range Setting Error].
- The display units for this parameter is 0.01 A.

The value set for $E2-01$ becomes the reference value for motor protection and the torque limit. Enter the motor rated current written on the motor nameplate. Auto-Tuning the drive will automatically set $E2-01$ to the value input for $T1-04$ [Motor Rated Current].

■ E5-03: Motor Rated Current (FLA)

No. (Hex.)	Name	Description	Default (Range)
E5-03 (032B)	Motor Rated Current (FLA)	<div style="display: flex; gap: 5px;"> V/f OLV OLV/PM AOLV/PM EZOLV </div> Sets the PM motor rated current (FLA).	Determined by $o2-04$, C6-01 (10% to 200% of the drive rated current)

Note:

The display units for this parameter is 0.01 A.

The drive automatically sets $E5-03$ to the value input for $T2-06$ [PM Motor Rated Current] after you do these types of Auto-Tuning:

- PM Motor Parameter Settings
- PM Stationary Auto-Tuning
- PM Stationary Tuning for Stator Resistance
- PM Rotational Auto-Tuning

■ E9-06: Motor Rated Current (FLA)

No. (Hex.)	Name	Description	Default (Range)
E9-06 (11E9)	Motor Rated Current (FLA)	<div style="display: flex; gap: 5px;"> V/f OLV OLV/PM AOLV/PM EZOLV </div> Sets the motor rated current in amps.	Determined by E9-01 and $o2-04$ (10% to 200% of the drive rated current)

Note:

The display units for this parameter is 0.01 A.

The setting value of $E9-06$ is the reference value for motor protection. Enter the motor rated current written on the motor nameplate. Auto-Tuning the drive will automatically set $E9-06$ to the value input for $T4-07$ [Motor Rated Current].

■ L1-01: Motor Overload (oL1) Protection

No. (Hex.)	Name	Description	Default (Range)
L1-01 (0480)	Motor Overload (oL1) Protection	V/f OLV OLV/PM AOLV/PM EZOLV Sets the motor overload protection with electronic thermal protectors.	Determined by A1-02 (0 - 6)

This parameter enables and disables the motor overload protection with electronic thermal protectors.

The cooling capability of the motor changes when the speed control range of the motor changes. Use an electronic thermal protector that aligns with the permitted load characteristics of the motor to select motor protection.

The electronic thermal protector of the drive uses these items to calculate motor overload tolerance and supply overload protection for the motor:

- Output Current
- Output Frequency
- Motor thermal characteristics
- Time characteristics

If the drive detects motor overload, the drive will trigger an *oL1* [*Motor Overload*] and stop the drive output.

Set $H2-01 = 1F$ [*Term MA/MB-MC Function Selection = Motor Overload Alarm (oL1)*] to set a motor overload alarm. If the motor overload level is more than 90% of the *oL1* detection level, the output terminal activates and triggers an overload alarm.

0 : Disabled

Disable motor protection when motor overload protection is not necessary or when the drive is operating more than one motor.

Refer to [Figure 17.2](#) for an example of the circuit configuration to connect more than one motor to one drive.

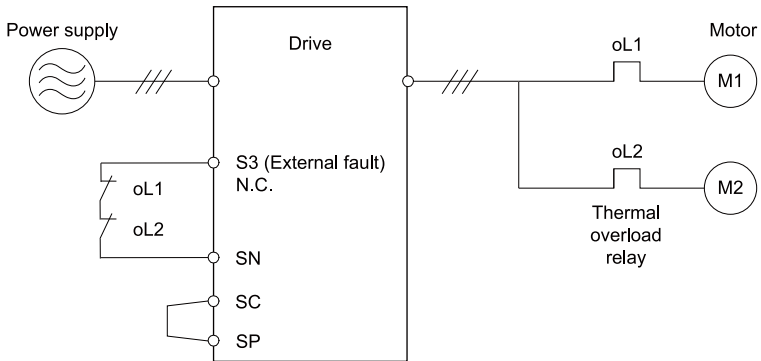

Figure 17.2 Protection Circuit Configuration to Connect More than One Motor to One Drive

NOTICE

When you connect more than one motor to one drive or when the motor amp rating is higher than the drive amp rating, set L1-01 = 0 [Motor Overload (oL1) Protection = Disabled] and install thermal overload relays for each motor. The electronic thermal protection of the drive will not function and it can cause damage to the motor.

1 : Variable Torque

Use this setting for general-purpose motors with a 60 Hz base frequency.

The overload tolerance decreases as motor speed decreases because the cooling fan speed decreases and the ability of the motor to cool decreases in the low speed range.

The overload tolerance characteristics of the motor change the trigger point for the electronic thermal protector. This provides motor overheat protection from low speed to high speed across the full speed range.

Load Tolerance	Cooling Capability	Overload Characteristics (at 100% motor load)
	<p>This motor is designed to operate with commercial line power. Operate at a 60 Hz base frequency to maximize the motor cooling ability.</p>	<p>If the motor operates at frequencies less than 60 Hz, the drive will detect oL1. The drive triggers a fault relay output and the motor coasts to stop.</p>

2 : Constant Torque 10:1 Speed Range

Use this setting for drive-dedicated motors with a speed range for constant torque of 1:10. The speed control for this motor is 10% to 100% when at 100% load. Operating slower than 10% speed at 100% load will cause motor overload.

Load Tolerance	Cooling Capability	Overload Characteristics (at 100% motor load)
	<p>This motor is designed to withstand increased temperatures during continuous operation in the low speed range (10% base frequency).</p>	<p>The motor operates continuously at 10% to 100% base frequency. Operating slower than 10% speed at 100% load will cause motor overload.</p>

3 : Constant Torque 100:1 SpeedRange

Use this setting for vector motors with a speed range for constant torque of 1:100.

The speed control for this motor is 1% to 100% when at 100% load. Operating slower than 1% speed at 100% load will cause motor overload.

Load Tolerance	Cooling Capability	Overload Characteristics (at 100% motor load)
	<p>This motor is designed to withstand increased temperatures during continuous operation in the low speed range (1% base frequency).</p>	<p>The motor operates continuously at 1% to 100% base frequency. Operating slower than 1% speed at 100% load will cause motor overload.</p>

4 : PM Variable Torque

Use this setting for PM motors with derated torque characteristics.

The overload tolerance decreases as motor speed decreases because the cooling fan speed decreases and the ability of the motor to cool decreases in the low speed range.

The overload tolerance characteristics of the motor change the trigger point for the electronic thermal protector. This provides motor overheat protection from low speed to high speed across the full speed range.

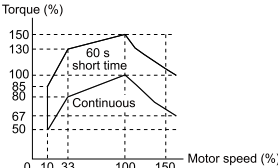
Load Tolerance	Cooling Capability	Overload Characteristics (at 100% motor load)
	<p>This motor is designed to withstand increased temperatures during continuous operation at rated speed and rated torque.</p>	<p>If the motor operates continuously at lower speed than rated rotation speed at more than 100% torque, the drive will detect <i>oLL</i>. The drive triggers a fault relay output and the motor coasts to stop.</p>

5 : PM Constant Torque

Use this setting with a PM motor for constant torque that has a speed range for constant torque of 1:500.

The speed control for this motor is 0.2% to 100% when at 100% load. Operating slower than 0.2% speed at 100% load will cause motor overload.

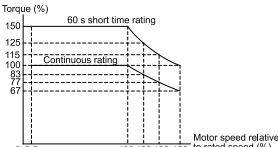
Load Tolerance	Cooling Capability	Overload Characteristics (at 100% motor load)
	<p>This motor is designed to withstand increased temperatures during continuous operation in the low speed range (0.2% base frequency).</p>	<p>The motor operates continuously at 0.2% to 100% rated speed. Operating slower than 0.2% speed at 100% load will cause motor overload.</p>

6 : Variable Torque (50Hz)

Use this setting for general-purpose motors with a 50 Hz base frequency.

The overload tolerance decreases as motor speed decreases because the cooling fan speed decreases and the ability of the motor to cool decreases in the low speed range.

The overload tolerance characteristics of the motor change the trigger point for the electronic thermal protector. This provides motor overheat protection from low speed to high speed across the full speed range.

Load Tolerance	Cooling Capability	Overload Characteristics (at 100% motor load)
	<p>This motor is designed to operate with commercial line power. Operate at a 50 Hz base frequency to maximize the motor cooling ability.</p>	<p>If the motor operates at frequencies less than commercial line power, the drive will detect <i>oL1</i>. The drive triggers a fault relay output and the motor coasts to stop.</p>

■ L1-02: Motor Overload Protection Time

No. (Hex.)	Name	Description	Default (Range)
L1-02 (0481)	Motor Overload Protection Time	<p><input type="checkbox"/> V/f <input type="checkbox"/> OLV <input type="checkbox"/> OLV/PM <input type="checkbox"/> AOLV/PM <input type="checkbox"/> EZOLV</p> <p>Sets the operation time for the electronic thermal protector of the drive to prevent damage to the motor. Usually it is not necessary to change this setting.</p>	1.0 min (0.1 - 5.0 min)

Set the overload tolerance time to the length of time that the motor can operate at 150% load from continuous operation at 100% load.

When the motor operates at 150% load continuously for 1 minute after continuous operation at 100% load (hot start), the default setting triggers the electronic thermal protector.

Figure 17.3 shows an example of the electronic thermal protector operation time. Motor overload protection operates in the range between a cold start and a hot start.

This example shows a general-purpose motor operating at the base frequency with L1-02 set to 1.0 min.

- Cold start
Shows the motor protection operation time characteristics when the overload occurs immediately after starting operation from a complete stop.
- Hot start
Shows the motor protection operation time characteristics when overload occurs from continuous operation below the motor rated current.

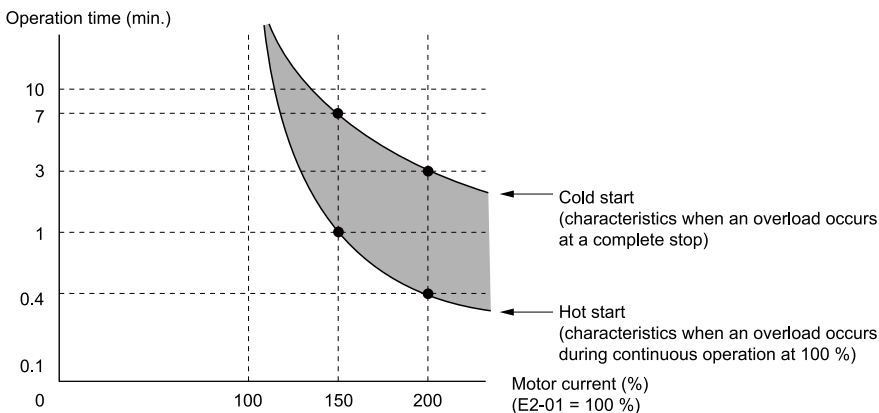

Figure 17.3 Protection Operation Time for a General-purpose Motor at Rated Output Frequency

■ L1-03: Motor Thermistor oH Alarm Select

No. (Hex.)	Name	Description	Default (Range)
L1-03 (0482)	Motor Thermistor oH Alarm Select	<input checked="" type="checkbox"/> V/f <input checked="" type="checkbox"/> OLV <input checked="" type="checkbox"/> OLV/PM <input checked="" type="checkbox"/> AOLV/PM <input checked="" type="checkbox"/> EZOLV Sets drive operation when the PTC input signal entered into the drive is at the oH3 [Motor Overheat Alarm] detection level.	3 (0 - 3)

0 : Ramp to Stop

The drive ramps the motor to stop in the deceleration time. The output terminal set for *Fault* [H2-01 to H2-03 = E] activates.

1 : Coast to Stop

The output turns off and the motor coasts to stop. The output terminal set for *Fault* [H2-01 to H2-03 = E] activates.

2 : Fast Stop

The drive stops the motor in the deceleration time set in C1-09 [Fast Stop Time]. The output terminal set for *Fault* [H2-01 to H2-03 = E] activates.

3 : Alarm Only

The keypad shows oH3 and the drive continues operation. The output terminal set for *Alarm* [H2-01 to H2-03 = I0] activates.

■ L1-04: Motor Thermistor oH Fault Select

No. (Hex.)	Name	Description	Default (Range)
L1-04 (0483)	Motor Thermistor oH Fault Select	 Sets the drive operation when the PTC input signal to the drive is at the oH4 [<i>Motor Overheat Fault (PTC Input)</i>] detection level.	1 (0 - 2)

0 : Ramp to Stop

The drive ramps the motor to stop in the deceleration time. The output terminal set for *Fault [H2-01 to H2-03 = E]* activates.

1 : Coast to Stop

The output turns off and the motor coasts to stop. The output terminal set for *Fault [H2-01 to H2-03 = E]* activates.

2 : Fast Stop

The drive stops the motor in the deceleration time set in *C1-09 [Fast Stop Time]*. The output terminal set for *Fault [H2-01 to H2-03 = E]* activates.

18 China RoHS Compliance



Figure 18.1 China RoHS Mark

The China RoHS mark is displayed on products containing six specified hazardous substances that are in excess of regulatory limits, based on the “Administrative Measures for the Restriction of the Use of Hazardous Substances in Electrical and Electronic Products” and “Marking for the Restricted Use of Hazardous Substances in Electronic and Electrical Products” (SJ/T 11364-2014), which were promulgated on January 26, 2016. The number displayed in the center of the mark indicates the environment-friendly use period (number of years) in which electrical and electronic products that are being produced, sold, or imported to China can be used. The date of manufacture of the electrical and electronic product is the starting date of the environment-friendly use period for the product. The six specified hazardous substances contained in the product will not leak outside of the product during normal use within this period and will have no serious impact on the environment, the human body, or property.

The environment-friendly use period for this product is 15 years. This period is not the product warranty period.

◆ Information on Hazardous Substances in This Product

Table 18.1 shows the details on hazardous substances contained in this product.

Table 18.1 Contents of Hazardous Substances in This Product

Parts Name	Hazardous Substances					
	Lead (Pb)	Mercury (Hg)	Cadmium (Cd)	Hexavalent Chromium (Cr(VI))	Polybrominated Biphenyls (PBB)	Polybrominated Diphenyl Ethers (PBDE)
Circuit Board	×	○	○	○	○	○
Electronic Parts	×	○	○	○	○	○
Brass Screw	×	○	○	○	○	○
Aluminum Die Casting	×	○	○	○	○	○

This table has been prepared in accordance with the provisions outlined in SJ/T 11364.

○: Indicates that said hazardous substance contained in all of the homogeneous materials for this part is below or equal to the limit requirement of GB/T 26572.

×: Indicates that said hazardous substance contained in at least one of the homogeneous materials used for this part is above the limit requirement of GB/T 26572.

Note:
This product complies with EU RoHS directives. In this table, "×" indicates that hazardous substances that are exempt from EU RoHS directives are contained.

19 对应中国RoHS指令



图 19.1 中国RoHS标志

中国RoHS标志依据2016年1月26日公布的《电器电子产品有害物质限制使用管理办法》，以及《电子电气产品有害物质限制使用标识要求》（SJ/T 11364-2014）作成。电子电气产品中特定6种有害物质的含量超过规定值时，应标识此标志。中间的数字为在中国生产销售以及进口的电子电气产品的环保使用期限（年限）。电子电气产品的环保使用期限从生产日期算起。在期限内，正常使用产品的过程中，不会有特定的6种有害物质外泄进而对环境、人和财产造成深刻影响。

本产品的环保使用期限为15年。但需要注意的是环保使用期限并非产品的质量保证期限。

◆ 本产品中含有有害物质的信息

本产品中所含有害物质的详细信息如表 19.1 所示。

表 19.1 本产品中有害物质的名称及含量

部件名称	有害物质					
	铅 (Pb)	汞 (Hg)	镉 (Cd)	六价铬 (Cr(VI))	多溴联苯 (PBB)	多溴二苯醚 (PBDE)
实装基板	×	○	○	○	○	○
电子元件	×	○	○	○	○	○
黄铜螺钉	×	○	○	○	○	○
铝压铸	×	○	○	○	○	○

本表格依据SJ/T 11364的规定编制。
 ○:表示该有害物质在该部件所有均质材料中的含量均在GB/T 26572规定的限量要求以下。
 ×:表示该有害物质至少在该部件的某一均质材料中的含量超出GB/T 26572规定的限量要求。
 (注) 本产品符合欧盟RoHS指令。上表中的“×”表示含有欧盟RoHS指令豁免的有害物质。

20 Safe Disable Input



Figure 20.1 TÜV Mark

The TÜV mark identifies that the product complies with the safety standards.

This section gives precautions to support the Safe Disable input. Contact Yaskawa for more information.

The safety function complies with the standards shown in Table 20.1.

Table 20.1 Applied Safety Standards and Unified Standards

Safety Standards	Unified Standards
Functional Safety	IEC/EN 61508:2010 (SIL3)
	IEC 62061:2005/AMD2:2015 (SILCL3)
	EN 62061:2005/A2:2015 (SILCL3)
	IEC 61800-5-2:2016 (SIL3) EN 61800-5-2:2017 (SIL3)
Machine Safety	ISO/EN ISO 13849-1:2015 (Cat.3, PL e)
EMC	IEC 61000-6-7:2014
	EN 61000-6-7:2015
	IEC/EN 61326-3-1:2017
LVD	IEC 61800-5-1:2007/AMD1:2016
	EN 61800-5-1:2007/A1:2017

Note:

SIL = Safety Integrity Level.

◆ Safe Disable Specifications

The Safe Disable input provides the stop function that complies with “Safe Torque Off” as specified by IEC/EN61800-5-2. The Safe Disable input meets the requirements of ISO/EN ISO 13849-1 and IEC/EN 61508. It also has a safety status monitor to detect safety circuit errors.

When you install the drive as a component in a system, you must make sure that the system complies with the applicable safety standards.

Refer to [Table 20.2](#) for safety function specifications.

Table 20.2 Safe Disable Specifications

Item	Description
Input/Output	<ul style="list-style-type: none"> Input: 2 Safe Disable input (H1, H2) Signal ON level: 18 Vdc to 28 Vdc Signal OFF level: -4 Vdc to +4 Vdc Output: 1 MFDO safety monitor output for external device monitor (EDM)
Response time from when the input opens to when the drive output stops	3 ms or less
Response time from when the H1 and H2 terminal inputs open to when the EDM signal operates	30 ms or less

Item		Description
Failure probability	Less frequent operation request mode	PFD = 1.38E ⁻⁵
	Frequent operation request mode or continuous mode	PFH = 3.35E ⁻⁹
Performance level		The Safe Disable input complies with the performance level requirements of EN ISO 13849-1.
HFT (hardware fault tolerance)		N = 1
Type of subsystem		Type B
MTTF _D		High
DCavg		Medium
Mission time		10 years

Note:

EDM = External Device Monitoring

PFD = Probability of Failure on Demand

PFH = Probability of Dangerous Failure per Hour

◆ Notes

⚠ DANGER *Sudden Movement Hazard. When you use the Safe Disable function in the safety system of a machine, do a full risk assessment for the system to make sure that all parts of the system comply with applicable safety standards. Incorrect application of the Safe Disable function can cause serious injury or death.*

⚠ DANGER *Sudden Movement Hazard. If the output circuit of the drive is damaged and the Safe Disable function turns OFF the drive output to a permanent magnet (PM) motor, the motor can rotate 180 electrical degrees. Prevent damage to equipment and injury to personnel during this condition. Sudden motor movement can cause serious injury or death. It is possible for current to flow through the motor winding in these conditions.*

⚠ DANGER *Electrical Shock Hazard. You cannot depend on the Safe Disable function to prevent electrical shock. Disconnect all power to the drive and wait for the time specified on the warning label before you remove covers. Check the drive for dangerous voltages before servicing or repair work. If you do work on the drive when it is energized and there is no cover over the electronic circuits, it can cause serious injury or death.*

⚠ WARNING *Sudden Movement Hazard. Although the Safe Disable function is in operation, gravity or other external forces in the vertical axis can move the motor. Incorrect application of the Safe Disable function can cause serious injury or death.*

⚠ WARNING *Sudden Movement Hazard. Do not use the drive output signals to control external holding brakes or dynamic brakes for functional safety. Use a system that conforms to the functional safety requirements. Incorrect application of the Safe Disable function can cause serious injury or death. Systems that use drive output signals (including EDM) for safety are not safe because drive output signals are not safety components.*

⚠ WARNING *Sudden Movement Hazard. Connect the Safe Disable inputs to the devices as specified by the safety requirements. If you connect the Safe Disable inputs incorrectly, it can cause serious injury or death.*

⚠ WARNING *Sudden Movement Hazard. To use the Safe Disable inputs, remove the jumpers between terminals H1-HC and H2-HC. If the Safe Disable circuit does not work correctly, it can cause serious injury or death.*

⚠ WARNING *Sudden Movement Hazard. When you clear the Safe Disable input, make sure that the Safe Disable Monitor output operates correctly as the specification for Safe Disable function. If the Safe Disable circuit does not operate correctly, it can cause serious injury or death.*

⚠ WARNING *Sudden Movement Hazard. Regularly examine the Safe Disable input and all other safety features. A system that does not operate correctly can cause serious injury or death.*

⚠ WARNING *Sudden Movement Hazard. Only let approved personnel who know about the drive, instruction manual, and safety standards wire, examine, and maintain the Safe Disable input. If personnel are not approved, it can cause serious injury or death.*

⚠ WARNING *Sudden Movement Hazard. Only use the Safe Disable Monitor (multi-function output terminal set to the EDM function) to monitor the Safe Disable status or to find a malfunction in the Safe Disable inputs. The monitor output is not a safety output. If you use the Safe Disable Monitor incorrectly, it can cause death or serious injury.*

Note:

- When you use a drive with a built in safety function, you must replace it 10 years after first use.
- A maximum of 3 ms will elapse from when terminals H1 or H2 shut off until the drive switches to the “Safe Torque Off” status. Set the OFF status for terminals H1 and H2 to hold for at least 3 ms. The drive may not be able to switch to the “Safe Torque Off” status if terminals H1 and H2 are only open for less than 3 ms.

◆ Using the Safe Disable Function

■ Safe Disable Circuit

The Safe Disable circuit has two isolated channels (terminals H1 and H2) that stop the output transistors. The input can use the internal power supply of the drive.

Set the EDM function to one of the MFDO terminals [$H2-xx = 21$ or 121] to monitor the status of the Safe Disable function. This is the “Safe Disable monitor output function”.

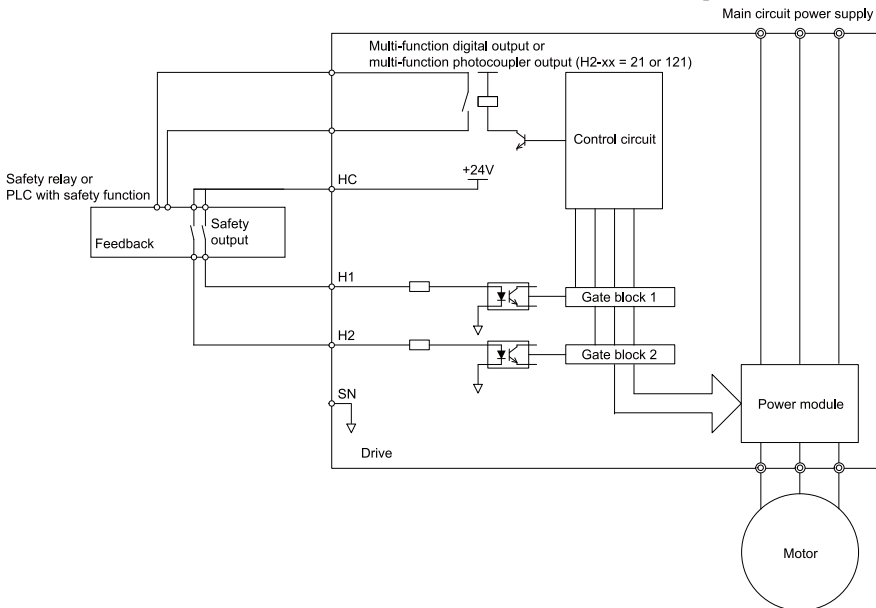

Figure 20.2 Safe Disable Function Wiring Example

■ Connect Safe Disable Input Contacts to Multiple Drives

To Use the Drive Internal Power Supply

Figure 20.3 shows an example of how to connect Safe Disable contacts.

From the terminals HC-SN of drive 1, supply the power for the Safe Disable function for the applicable drives. These conditions limit the number of units to connect:

- Internal power supply capacity
- Number of MFDIs used
- Supply current to the external sensors

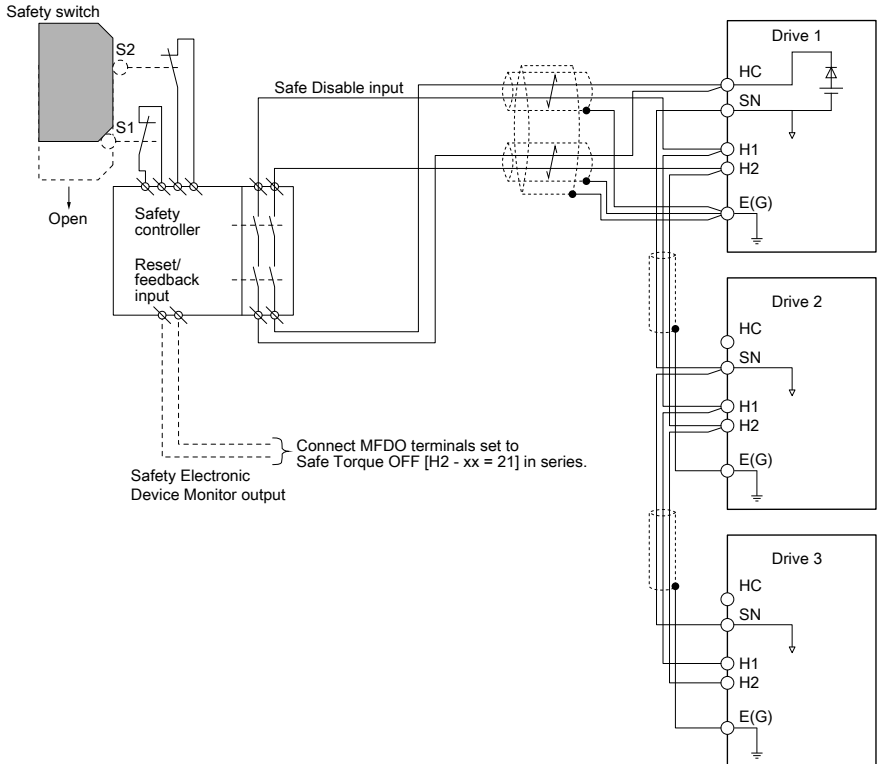

Figure 20.3 Connection Example to Use the Internal Power Supply

To Use 24 V External Power Supply

Figure 20.4 shows an example of how to connect Safe Disable contacts. These conditions limit the number of units to connect:

- External power supply capacity
- Number of MFDIs used
- Supply current to the external sensors

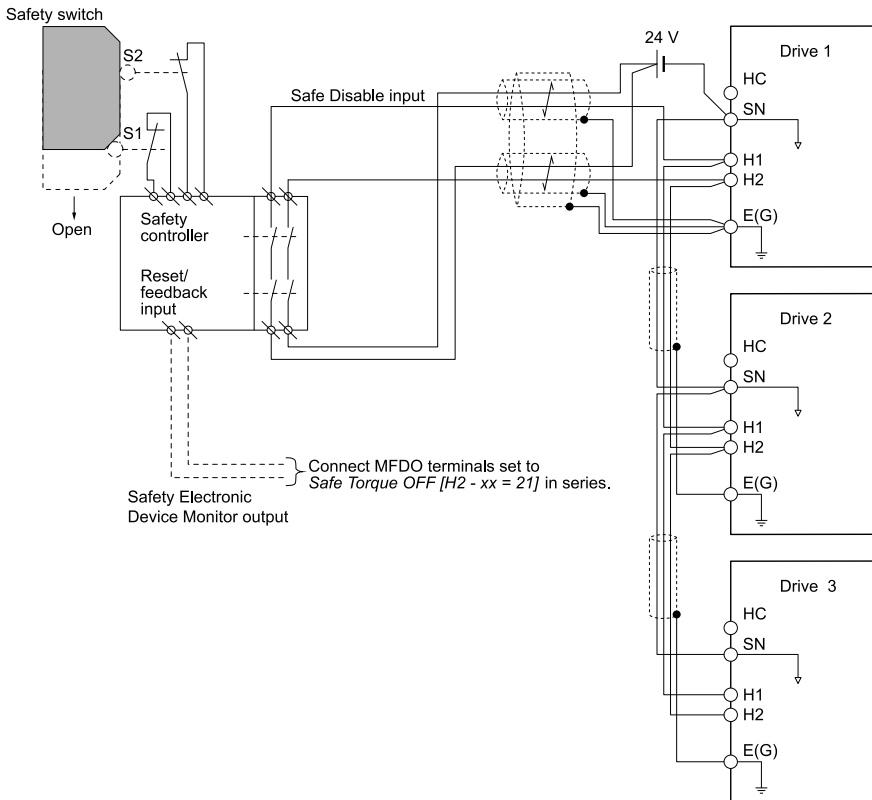

Figure 20.4 Connection Example to Use 24 V External Power Supply

Number of Possible Drives to Connect

Power Supply	Digital Inputs	24 V Output	Number of Drives
Internal power supply (Drive 1)	Yes (7-channel input)	Yes ^{*1}	1
		No	13
	No	Yes ^{*1}	4
		No	17
External power supply	-	-	Different for different external power supply capacities ^{*2}

*1 This is when you use a maximum of 150 mA.

*2 24 V, 12 mA is necessary for each drive.

Use this formula to calculate the number of units to connect:

$$n = (I_{\max} - I_{\text{MFDI}} \times n_{\text{MFDI}} - I_{\text{sensor}}) / I_{\text{safety}}$$

- n: Number of units to connect
- I_{\max} : Maximum current that the power supply can supply (234 mA for the internal power supply)
- I_{MFDI} : Current consumed per MFDI (6 mA)
- n_{MFDI} : Maximum number of MFDIs that can be activated at the same time (maximum of 7-channel)
- I_{sensor} : Current externally supplied for sensor power supply (maximum of 150 mA)
- I_{safety} : Current consumed by Safe Disable terminals H1 and H2 (12 mA)

Note:

Round the values to the first decimal place.

■ Enabling and Disabling the Drive Output (“Safe Torque Off”)

Refer to [Figure 20.5](#) for an example of drive operation when the drive changes from “Safe Torque Off” status to usual operation.

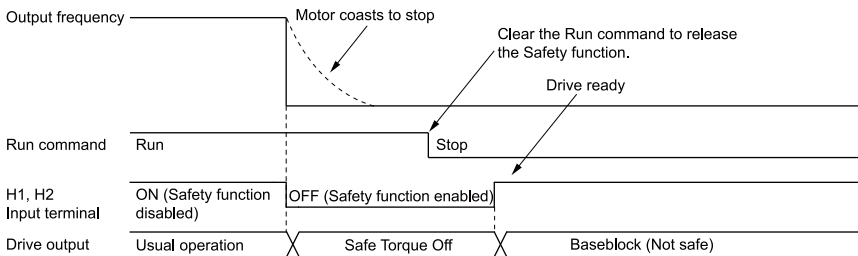

Figure 20.5 Safe Disable Operation

Switching from Usual Operation to “Safe Torque Off”

Turn OFF (open) safety input terminal H1 or H2 to enable the Safe Disable function. When the Safe Disable function is enabled while the motor is operating, the drive output and motor torque turn off and the motor always coasts to stop. The *b1-03 [Stopping Method Selection]* setting does not have an effect on the stopping method.

The “Safe Torque Off” status is only possible with the Safe Disable function. Clear the Run command to stop the drive. Turning off drive output (a baseblock condition) ≠ “Safe Torque Off”.

Note:

- When it is necessary to ramp to stop the motor, do not turn off terminals H1 and H2 until the motor fully stops. This will prevent the motor from coasting to stop during usual operation.
- A maximum of 3 ms will elapse from when terminals H1 or H2 shut off until the drive switches to the “Safe Torque Off” status. Set the OFF status for terminals H1 and H2 to hold for at least 3 ms. The drive may not be able to switch to the “Safe Torque Off” status if terminals H1 and H2 are only open for less than 3 ms.

Going from “Safe Torque Off” to Usual Operation

The safety input will only release when there is no Run command.

- **During Stop**
When the Safe Disable function is triggered during stop, close the circuit between terminals H1-HC and H2-HC to disable “Safe Torque Off”. Enter the Run command after the drive stops correctly.
- **During Run**
If you trigger the Safe Disable function during run, clear the Run command, then close the circuit between terminals H1-HC and H2-HC to disable “Safe Torque Off”. Enter the Stop command, then enter the Run command when terminals H1 and H2 are activated.

■ Safe Disable Monitor Output Function and Keypad Display

Refer to [Table 20.3](#) for information about the relation between the input channel status, Safety monitor output status, and drive output status.

Table 20.3 Safe Disable Input and External Device Monitor (EDM) Terminal Status

Input Channel Status		Safety Monitor Output Status		Drive Output Status	Keypad Display	READY LED	MEMOBUS Register 0020H	
Input 1 (H1-HC)	Input 2 (H2-HC)	MFDO Terminal (H2-xx = 21)	MFDO Terminal (H2-xx = 121)				bit C	bit D
ON (Close the circuit)	ON (Close the circuit)	OFF	ON	Baseblock (Drive ready)	Normally displayed	READY: Illuminated	0	0
OFF (Open)	ON (Close the circuit)	OFF	ON	Safety status (STo)	SToF (Flashing)	ALM/ ERR: Flashing	1	0
ON (Close the circuit)	OFF (Open)	OFF	ON	Safety status (STo)	SToF (Flashing)	ALM/ ERR: Flashing	1	0
OFF (Open)	OFF (Open)	ON	OFF	Safety status (STo)	STo (Flashing)	READY: Flashing	0	1

Safety Function Status Monitor

The drive Safety monitor output sends a feedback signal about the status of the Safety function. The Safety monitor output is one of the possible settings available for the MFDO terminals. If there is damage to the Safe Disable circuit, a controller (PLC or safety relay) must read this signal as an input signal to hold the “Safe Torque Off” status. This will help verify the condition of the safety circuit. Refer to the manual for the safety device for more information about the Safety function.

It is possible to switch polarity of the Safety monitor output signal with the MFDO function settings. Refer to [Table 20.3](#) for setting instructions.

Keypad Display

If the two input channels are OFF (Open), the keypad will flash *STo* [*Safe Torque OFF*].

If there is damage to the Safe disable circuit or the drive, the keypad will flash *SToF* [*Safe Torque OFF Hardware*] when one input channel is OFF (Open), and the other is ON (Short circuit). When you use the Safe disable circuit correctly, the keypad will not show *SToF*.

If there is damage to the drive, the keypad will show *SCF* [*Safety Circuit Fault*] when the drive detects a fault in the Safe disable circuit. Refer to the chapter on Troubleshooting for more information.

■ Validating the Safe Disable Function

After you replace parts or do maintenance on the drive, complete all necessary wiring to start the drive, then follow these steps to test the Safe Disable input. Keep a record of the test results.

1. When the two input channels are OFF (Open), make sure that the keypad flashes *STo [Safe Torque OFF]*, and make sure that the motor is not running.
2. Monitor the ON/OFF status of the input channels and make sure that MFDO set to the EDM function operates as shown in [Table 20.3](#).
If one or more of the these items are true, the ON/OFF status of the MFDO may not display correctly on the keypad.
 - Incorrect parameter settings.
 - A problem with an external device.
 - The external wiring has a short circuit or is disconnected.
 - There is damage to the device.Find the cause and repair the problem to correctly display the status.
3. Make sure that the EDM signal operates during usual operation as shown in [Table 20.3](#).

21 Australian Standard



Figure 21.1 Regulatory Compliance Mark

The Regulatory Compliance Mark (RCM) identifies that the product meets the requirements of the related ACMA Standards in the Radiocommunications Act of 1992 and the Telecommunications Act of 1997.

22 Disposal

◆ Disposal Instructions

Correctly dispose of the product and packing material as specified by applicable regional, local, and municipal laws and regulations.

◆ WEEE Directive

The wheeled bin symbol on this product, its manual, or its packaging identifies that you must recycle it at the end of its product life.

You must discard the product at an applicable collection point for electrical and electronic equipment (EEE). Do not discard the product with usual waste.

Revision History

Date of Publication	Revision Number	Section	Revised Content
November 2021	1	All	Revision: Reviewed and corrected entire documentation. Addition: Larger drive capacities added along with corresponding data. <ul style="list-style-type: none">• Three-Phase 200 V: CIPR-GA50x2030 to 2070• Three-Phase 400 V: CIPR-GA50x4018 to 4038
		17	Revision: Short Circuit Protection
		22	Addition: Australian Standard
February 2021	-	-	First Edition

YASKAWA AC Drive GA500

Installation & Primary Operation

YASKAWA AMERICA, INC.

2121, Norman Drive South,
Waukegan, IL 60085, U.S.A.
+1-800-YASKAWA (927-5292)
www.yaskawa.com

DRIVE CENTER (INVERTER PLANT)

2-13-1, Nishimiyaichi, Yukuhashi,
Fukuoka, 824-8511, Japan
Phone: +81-930-25-2548
www.yaskawa.co.jp

YASKAWA EUROPE GmbH

Hauptstraße 185, 65760 Eschborn,
Germany
Phone: +49-6196-569-300
E-mail: support@yaskawa.eu.com
www.yaskawa.eu.com

YASKAWA ELÉTRICO DO BRASIL LTDA.

777, Avenida Piraporinha,
Diadema, São Paulo, 09950-000,
Brasil
Phone: +55-11-3585-1100
www.yaskawa.com.br

In the event that the end user of this product is to be the military and said product is to be employed in any weapons systems or the manufacture thereof, the export will fall under the relevant regulations as stipulated in the Foreign Exchange and Foreign Trade Regulations. Therefore, be sure to follow all procedures and submit all relevant documentation according to any and all rules, regulations and laws that may apply. Specifications are subject to change without notice for ongoing product modifications and improvements.

Original instructions.

© 2021 YASKAWA Electric Corporation

YASKAWA ELECTRIC CORPORATION

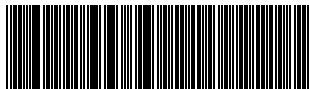

TOEPC7106170Y

TOEPC7106170Y
Revision: B <1>->0
November 2021
Published in Japan
20-2-22_YAI

YASKAWA